

# Lyman<sup>®</sup> 2019



*Innovative Products for Hunters & Shooters Since 1878*

**Pachmayr**

**★ TACSTAR<sup>®</sup>**

**A-ZOOM<sup>®</sup>**

**TRIUS<sup>®</sup>**  
*Traps*

*Butch's*



Dear Fellow Shooters -

As we approach 2019, our 141st year in business, all of us at Lyman recognize that today's customer demands more than ever before and if companies do not adapt they are yesterday's news. That's why at Lyman we believe that continuous improvements to our existing products are just as important as bringing new products to market.



*The Crew from our Arizona plant!*

In 2018 we boldly introduced the next generation of our popular reloading line with our new **Brass Smith** series of products. This was a major achievement for our engineering team and manufacturing personnel. Our new **All American 8 Turret Press, Victory Single Stage**, and the affordable **Ideal C-Frame** presses replaced our popular T-Mag and Crusher models. Based on the demand for these models and the many 5 Star reviews, our customers gave us a big "Thumbs Up!" This year press owners can enjoy their new presses even more with our new **Universal Press Stand** which accommodates all Lyman and most other popular press models.

In 2019 we continue to build on the new Brass Smith series with our new **Case Trim Xpress**, which is the simplest, fastest, and most efficient way to trim cases that you will find anywhere. It comes complete with a high speed motor, carbide cutter, and 10 bushings for the most popular calibers so reloaders can easily trim up to 15 cases per minute, with perfect accuracy.

This year for our concealed carry customers we expanded our growing line of Pachmayr products by adding two new models to our revolutionary and patented **GuardianGrip** series; the Ruger LCR and Taurus 85/856. Competition shooters will also be excited to hear we also added four new models to our new line of **Aluminum Speed Loaders**.

The growing population of Long Range shooters will appreciate the added comfort of our new **Tac-Mat Shooting Mats**. Finally, safety training just got better with two great new products from our award winning A-Zoom snap cap product line. The new **A-Zoom Blue Value** packs offer great savings in a distinctive new color and our new **Striker Caps** allow continuous racking of the slide without ejecting for quicker and easier dry fire training.

These are just a few of the new products and innovations that shooters have come to expect from Lyman. As always, our success lies in the hands of our customers. We are always interested in hearing your ideas and ways to improve our company and our sport. Please stay in touch through our newsletter and share your thoughts with us on Facebook and Instagram.

Thanks and best wishes in 2019!

Rick Ranzinger, President & CEO

**How to Contact Us: Lyman 1-860-632-2020 or toll free at 1-800-22-Lyman • For Pachmayr/TacStar Products:1-800-423-9704  
Fax: 1-860-632-1699 or write to: Lyman Products Corp., 475 Smith Street, Middletown, CT 06457**

Lyman, Pachmayr, TacStar, Trius, Uni-dot, A-Zoom, TurboSonic, Universal Trimmer, Prefit Recoil Pads, Decelerator, White Line, Vindicator, Bleacher Block, Auto Advance, Borecam, G10 Tactical, Renegade, Targ-Dots, Turbo® Tumbler, Pac-Skin, MagDriver, Butch's, SideSaddle, Turbo Sonic Solutions, Ideal, Victory, Brass Smith, and GuardianGrip are registered trademarks of Lyman Products Corp.

All-American 8, Case Trim Xpress, Cyclone, Qwik Draw, Great Plains, AccuTrimmer, Powder Pal, E-Zee Case Gauge, E-ZEE Prime, Gen5, Gen6, Accu-Touch, Micro-Touch, E-ZEE Trim, Case Prep Xpress, Multi-Tool, Quick Slick, Orange Magic, Black Powder Gold, American Legend Grips, Diamond Pro, Tactical Grip Gloves, Auto-Flo, Signature, Compac, Gripper, Sure-Grip, Crusher, Ammo Checkers, E-ZEE Flo, Pocket Touch, Pro-Touch, TargetMan, Bleacher Block, Universal are trademarks of Lyman Products Corp.

Eyepal is a registered trademark of RAS, LLC. Flippin' Critters is a registered trademark of Flippin' Critters LLC

©2019, Lyman Products Corporation, printed in U.S.A. All other trademarks in this catalog are the property of their respective owners.

**Lyman**

Brass Smith Reloading Presses & Kits . . . . . 2-4  
**NEW Universal Press Stand & Dust Cover . . . . . 3**  
**NEW Case Trim Xpress & Brass Smith Funnel System . . . 5**  
 Powder Measures & Powder Handling . . . . . 6-7  
**NEW Brass Smith 500 Scale & Powder Trickler . . . . . 7**  
 Electronic Scales . . . . . 8-9  
 E-ZEE Prime & Stuck Case Remover . . . . . 10  
**NEW MSR Die Sets and Creedmoor Dies . . . . . 11**  
 Dies & Die Sets . . . . . 11-17  
 Handbooks & Publications . . . . . 18-19  
 Long Range Precision Rifle Handbook . . . . . 19  
 Cyclone Rotary Tumbler . . . . . 20  
**NEW Stainless Steel Pin Magnet . . . . . 20**  
 Cyclone Case Dryer . . . . . 21  
 Ultrasonic Cleaners & Solutions . . . . . 22  
 Power Pro . . . . . 23  
 Tumblers & Accessories . . . . . 24-27  
 Super Moly Products . . . . . 27  
 Trimmers . . . . . 28-29  
 Case Prep Tools & Accessories . . . . . 30-33  
**NEW E-ZEE MSR & Cowboy Case Gauges . . . . . 33**  
 Loading Blocks . . . . . 34-35  
 Calipers, Micrometers & Gauges . . . . . 36  
**NEW Ammo Checkers . . . . . 37**  
 Casting Equipment, Moulds . . . . . 38-44  
**NEW Pistol Moulds . . . . . 42**  
 Model of 1878 Centerfire Rifle . . . . . 45  
 Black Powder Rifles . . . . . 46-47  
**NEW Henry Rifle Tang Sight . . . . . 48**  
 Sights . . . . . 48-49  
**NEW Long Range Shooting Mats . . . . . 50**  
 Target Stands . . . . . 50  
 Shooting Bags, Starter Kit, Flippin' Critters . . . . . 51  
 Cleaning Kits, Qwik Draw . . . . . 52  
 TargDots & Trigger Pull Gauge . . . . . 53  
 Borecam Borescope . . . . . 54  
 Cleaning Rods, Bore Guide, Jag & Brush Set . . . . . 54  
 Butch's Gun Care Products . . . . . 55  
 Gun Mats . . . . . 55  
 Lyman Gunsmith Tools . . . . . 56-57

**Pachmayr**

Pachmayr Gunsmith Tools . . . . . 58-59  
 Pac-Mag . . . . . 59  
 Recoil Pads . . . . . 60-64

Pad Selection Guide . . . . . 65  
**NEW Renegade Slip-On Recoil Pads . . . . . 66**  
 Custom Series Pistol Grips . . . . . 67  
 G10 Tactical Pistol Grips . . . . . 68-69  
 Renegade Wood Laminate Pistol Grips . . . . . 70-71  
**NEW Shockwave Tactical Shotgun Grip Glove . . . . . 72**  
 Tactical Grip Gloves . . . . . 72-73  
 Semi-Auto Pistol Grips . . . . . 74  
 American Legend Grips for 1911 & Revolver . . . . . 75  
 Slip-On Grips, 1911 Accessories . . . . . 76  
 T/C Contender, Vindicator Grips . . . . . 76  
**NEW GuardianGrip . . . . . 77**  
**NEW Speedloaders . . . . . 77**  
 G10 Revolver Grips . . . . . 78  
 Renegade Revolver Grips . . . . . 79  
 Revolver Grips . . . . . 80  
 Diamond Pro Grips . . . . . 81  
 Grip Extenders . . . . . 82  
 Mag Sleeves . . . . . 83

**TacStar**

Magazine Extensions . . . . . 84  
 Carbon Fiber HandGuards . . . . . 85  
 SideSaddles . . . . . 86,87  
 Shotgun Grips . . . . . 88  
 Brass Catcher & Shotgun Accessories . . . . . 89  
 Adjustable Match Rifle Stock . . . . . 90  
 AR Grips & Recoil Pad . . . . . 90  
 Collapsible AR Stock & Adapters . . . . . 91  
 Weapons Light System & Rail Mounts . . . . . 92

**A-Zoom**

**NEW A-Zoom Blue Value Packs . . . . . 93**  
**NEW A-Zoom Striker Caps . . . . . 94**  
 Precision Metal Snap Caps . . . . . 93-94

**Trius**

Launchpad Electric Trap Thrower . . . . . 95  
 Clay Target Traps . . . . . 96-97  
 Eyepal Sight Enhancer . . . . . 97



## Brass Smith Ideal Press

Lyman's Brass Smith Ideal Press is the perfect starting point for beginners or as a precision companion press for experienced reloaders. The compact design of the Ideal Press requires minimal bench space, but it is not some flimsy lightweight! The rugged press frame is made of cast iron, while other components are all steel. The press features compound linkage for optimum leverage, a 1" diameter ram, and a 3 7/8" press opening which can handle all pistol calibers and rifle cartridges with a loaded length of up to 3.700". The press has a central handle position for easy ambidextrous use and a ball handle for comfortable operation. The Ideal Press accepts all 7/8x14 thread dies and standard shell holders. The press will provide accuracy and precision for beginners or experts, and is the perfect auxiliary press for those wishing to perform a specific operation separate from their main press.

- Rugged cast iron frame
- Ambidextrous design
- Handles all pistol calibers and rifle cartridges up to 3.700 in length
- Accepts all standard 7/8"x14 dies and standard shell holders
- Durable powder coat finish
- Compound linkage and 1" diameter ram
- Weight 12.6 pounds

Brass Smith Ideal Press ..... (#7726500)



The large frame opening makes even the largest magnum calibers easy to load



Compound linkage and 1" diameter ram



For added safety, the primer feed comes with a heavy steel shield which surrounds the primer tubes

## Brass Smith Victory Press

The Lyman Brass Smith Victory Press is the workhorse of our line. You cannot find a more sturdy, rugged, and rigid single station press available. We started with a heavy duty cast iron "O" frame, and added a 1" diameter ram, and compound linkage. Work the press handle and you will feel the tight, precision fit and smooth operation. Unlike many competitive presses, the Victory Press comes with a newly designed straight line primer feed. The straight line primer feed is completely reliable and simple to use. Simply push the priming arm forward at the bottom of the ram travel to position it beneath the shell holder. For added safety, the primer feed comes with a heavy steel shield which surrounds the primer tubes. The large 5" frame opening makes even the largest magnum calibers easy to load. The Victory Press is equipped with a comfortable ball handle which can be positioned for either right or left hand use. The Victory Press is designed for use with any standard 7/8"x14 thread dies and accepts standard shell holders.

- Heavy duty cast iron "O" frame
- 1" diameter ram
- Comes with straight line primer feed with large and small primer tubes
- Precision fit and smooth operation
- Large 5" frame opening, works with the largest cases
- For added safety, the primer feed comes with a heavy steel shield which surrounds the primer tubes.
- Right or left hand operation
- Durable powder coat finish
- Weight 18.1 pounds

Brass Smith Victory Press ..... (#7726350)



Ambidextrous design for right or left hand operation



Holds two complete 4 die sets or up to four 2 die sets

**For pricing visit our website  
www.lymanproducts.com**



**Brass Smith All-American 8 Turret Press**

The eight station Brass Smith All-American 8 Press is the most feature-packed, rugged turret press on the market! Starting at the top, the extra-large 8 station turret is machined out of heavy duty cast iron. It is equipped with an easily removed turret bolt which makes swapping turrets simple. The 8 die station turret is the largest available and will hold two complete 4 die sets or up to four 2 die sets. Below the turret is a rigid cast iron frame, housing a 1" diameter ram and compound linkage. The frame is large enough to work with even the longest rifle cartridges. Work the press handle and you will feel the tight, precision fit and smooth operation. Unlike many competitive presses, the Brass Smith All-American 8 Press comes with a newly designed straight line primer feed. The straight line primer feed is completely reliable and simple to use. Simply push the priming arm forward at the bottom of the ram travel to position it beneath the shell holder. For added safety, the primer feed comes with a heavy steel shield which surrounds the primer tubes. The Brass Smith All-American 8 Press is equipped with a comfortable ball handle which can be positioned for either right or left hand use. The Brass Smith All-American 8 Press is designed for use with any standard 7/8"x14 thread dies and accepts standard shell holders.

- Heavy duty cast iron frame and turret
- Extra-large 8 station turret is easily removed to make swapping turrets simple.
- Holds two complete 4 die sets or up to four 2 die sets
- 1" diameter ram
- Comes with straight line primer feed with large and small primer tubes
- Precision fit and smooth operation
- Large press opening, works with the largest cases
- For added safety, the primer feed comes with a heavy steel shield which surrounds the primer tubes.
- Right or left hand operation
- Durable powder coat finish
- Weight 23 pounds

Brass Smith All-American 8 Press . . . . . (#7040750)  
 Extra Turret . . . . . (#7726165)



**Lyman Universal Press Stand**

The Lyman Universal Press Stand is the only press stand on the market that will accept most current single station, turret, and progressive presses of all brands. This heavy duty steel stand comes with two mounting plates pre-drilled for your favorite single station, turret, or progressive press. If by chance you have a press that does not match up with any of the numerous patterns, there is also a blank area where you can drill your own mounting holes. The stand will raise your press 9 1/4" above your bench surface, which will lessen fatigue from having to bend over to cycle your press and provides a clear view of all reloading operations. All hardware needed to mount your press is included. The Universal Press Stand is drilled to allow it to be bolted to your bench, or it can be C-clamped to provide quick removal if desired.

- All steel, heavy duty construction
- Accepts most single station, turret, and progressive presses
- Blank area allows custom drilling
- Raises your press 9 1/4" for a clear view of reloading operations
- Reduces fatigue
- Press mounting hardware is included
- Fits the following presses and more:  
 Lyman - Crusher, T-Mag, Ideal C-Frame, Victory, All-American 8 Turret,  
 RCBS - Rock Chucker, Rock Chucker Supreme, RCBS Turret, Pro 2000,  
 Hornady - AP, Iron, Lock-N-Load Classic,  
 Redding - T7, Lee - Load Master, Pro 1000, Classic, Value Turret,  
 Dillon - Square Deal, 550, 650

Universal Press Stand . . . . . (#7726750)

**Press Dust Cover**

Protect your investment in top quality Lyman Presses with a Lyman Press Dust Cover. This simple cover will protect your presses from dust and dirt, maintaining their "like new" condition for years to come! Plus the good looking cover will make your reloading bench appear neat and organized.

Press Dust Cover . . . . . (#7726740)



**For pricing visit our website  
[www.lymanproducts.com](http://www.lymanproducts.com)**

## BRASS SMITH IDEAL RELOADING KIT

Lyman's Ideal Reloading Kit is the perfect starter kit for the new reloader. It features all the essential tools that you need but will never out grow as your experience increases. The kit includes Lyman's new Ideal Press, equipped with a rugged 1" ram and capable of handling all pistol and rifle cartridges up to 3.700" in length. You also get our new Brass Smith Powder Measure, our popular E-ZEE Prime Hand Priming Tool, the famous 50th Edition Reloading Handbook, the Pocket Touch 1500 digital scale with Funnel Pan and dipper, as well as the Case Prep Multi-Tool, loading block and Quick Slick Case Lube. All for a price that is a large savings over individual purchases!

Ideal Kit Includes:

- Brass Smith Ideal Press
- Brass Smith Powder Measure
- 50th Edition Reloading Handbook
- Pocket Touch 1500 electronic scale with Funnel Pan and Dipper
- Loading Block
- Case Prep Multi-Tool
- E-ZEE Prime Hand Priming Tool
- Quick Slick Case Lube

Brass Smith Ideal Kit (#7810350) 



## BRASS SMITH VICTORY RELOADING KIT

Lyman used all 140 years of their reloading experience with the design of the new Brass Smith Victory Press. This workhorse cast iron press is equipped with our completely new Auto Primer Feed and is the most rugged yet precise single stage press available. Perfect for precision rifle shooters, the Brass Smith Victory Reloading Kit gives reloaders all of the expert grade equipment that they need! The kit features the heavy duty Victory Press, our new Brass Smith Powder Measure, the famous 50th Edition Reloading Handbook, 1500 grain capacity Pocket Touch Digital Scale with Funnel Pan and dipper, Case Prep Multi-Tool, our Magnum Bullet Puller as well as a loading block and Case Lube Kit.

Single Stage Press Kit includes:

- Brass Smith Single Stage Press
- Brass Smith Powder Measure
- 50th Edition Reloading Handbook
- Pocket Touch 1500 electronic scale with Funnel Pan and Dipper
- Loading Block
- Case Prep Multi-Tool
- Magnum Bullet Puller
- Primer Tray
- E-ZEE Powder Funnel
- Case Lube Kit
- Powder Dribbler

Brass Smith Single Stage Kit (#7810360) 



## BRASS SMITH ALL-AMERICAN 8 RELOADING KIT

Lyman is proud to be celebrating our 140 years in business; however we are even prouder of our new All-American 8 Press. Our new turret press is the most features packed, rugged press on the market, and is the heart of the All-American 8 Reloading Kit. The heavy duty press is large enough to handle the biggest rifle cartridges, yet offers speed and precision for pistol shooters. Along with the smooth operating 8-station turret capable of holding up to 4 two die sets, the press is equipped with our brand new straight line Auto Primer Feed. To make this the most complete kit that you can find, we have included our new Brass Smith Powder Measure, our Universal Trimmer with 9 of the most popular caliber pilots, our 1500 grain capacity Pocket Touch Digital scale, the famous 50th Edition Reloading Handbook, our Magnum Bullet Puller, Case Prep Multi-Tool, loading block Case Lube Kit and Powder Dribbler.

All-American 8 Reloading Kit includes:

- Brass Smith All-American 8 Press
- Brass Smith Powder Measure
- 50th Edition Reloading Handbook
- Pocket Touch 1500 electronic scale with Funnel Pan and Dipper
- Universal Trimmer with pilot multi-pack
- Case Prep Multi-Tool
- Magnum Bullet Puller
- Case Lube Kit
- Loading Block
- Powder Dribbler
- E-ZEE Powder Funnel
- Primer Tray

Brass Smith All-American 8 Kit (#7810370) 



**For pricing visit our website**  
**[www.lymanproducts.com](http://www.lymanproducts.com)**

 **WARNING:** Cancer and Reproductive Harm  
[www.p65warnings.ca.gov](http://www.p65warnings.ca.gov)



**Brass Smith Case Trim Xpress™**

Lyman's Case Trim Xpress gives rifle reloaders the speed and accuracy that they have been looking for when trimming cases! The unit has its own power source, and a strong variable speed motor, so there is no need to use power drills or purchase separate motors. By using bushings that contact on the shoulder of bottle neck type cases, the Case Trim Xpress will quickly and cleanly trim your brass by simply pushing the case against the long lasting carbide cutter. The trimmer comes with a set of 10 bushings (in orange type below) designed to fit most popular bottleneck rifle cases. The bushings support and center the case with the cutter. No pilots are needed! The bushings are spring loaded to provide a smooth, effortless cut; and allow the user to trim approximately 15 cases per minute. In addition, the Case Trim Xpress is equipped with an adjustment wheel, which allows case lengths to easily be "dialed in" to .001" increments. Plus the Case Trim Xpress is made with a compact, low profile housing that doesn't eat up all of your bench space.

- Fast and accurate trims – approximately 15 cases per minute
- Variable speed motor and ultra-sharp, long lasting carbide cutter
- Utilizes case shoulders to center & trim **(Not for use on straight wall cases)**
- Comes with 10 bushings fitting most popular bottleneck rifle cartridges
- Smooth spring-loaded operation gives clean, chatter-free trims
- Compact, low profile design uses minimal bench space
- No pilots needed

Brass Smith Case Trim Xpress 115V . . . (#7862015)  
 Brass Smith Case Trim Xpress 230V . . . (#7862016)

**Endurance  
 Tested for a  
 Lifetime of Use**

**Item # Individual Bushings: (\*orange are incl. w/Trimmer)**

7821701	#1	(17 Hornet, 22 Hornet)
7821702	#2	(218 Bee)
7821703	#3	(.223 Rem.,.17 Rem.,.204 Ruger,.221 Fireball,.222 Rem.,.222 Rem Mag,5.56 x 45)*
7821704	#4	(300 AAC,17 Rem Fireball)*
7821705	#5	(30 30 Win,6.8 Rem SPC,22 Nosler,24 Nosler,224 Valkyrie)*
7821706	#6	(220 Swift)
7821707	#7	(303 British,7.62 x 39,30-40 Krag,6.5 Grendel)
7821708	#8	(22-250 Rem,250 Savage,35 Remington)*
7821709	#9	(6mm Rem,7mm Mauser,8mm Mauser,257 Roberts)*
7821710	#10	(30/06,25/06,270 Win,.280 Rem,35 Whelen,6.5 Swedish)*
7821711	#11	(9.3 x 74r)
7821712	#12	(.308 Win,.243 Win,.260 Rem,7mm/08,338 Federal,358 Win,300 Savage,9.3 x 62,6x47 Lapua,6 XC,6.5x47 Lap.)*
7821713	#13	(6.5mm Creedmoor,6mm Creedmoor,6mm BR Norma,.22 BR,6mm Dasher)*
7821714	#14	(375 H&H Mag)
7821715	#15	(7.62 x 54R)
7821716	#16	(.284 Win,6.5 x 284,6 x 284)
7821717	#17	(416 Rem Mag,8mm Rem Mag)
7821718	#18	(.300 Win Mag,.264 Win Mag,7mm Rem Mag,7mm STW,.308 Norma Mag,.338 Win Mag)*
7821719	#19	(300 RCM,338 RCM,375 Ruger)
7821720	#20	(.338 Ultramag,7mm Ultramag,.300 Ultramag,.338 Edge,375 RUM)
7821721	#21	(30 Nosler,28 Nosler,27 Nosler,26 Nosler)
7821722	#22	(7mm Rem SAUM, .300 Rem SAUM)
7821723	#23	(.300 WSM,.325 WSM,.270 WSM,7mm WSM)*
7821724	#24	(338 Lapua)
7821725	#25	(416 Rigby)

**Brass Smith Precision Funnel Set**

Lyman's Precision Funnel Set is the "Perfect" system for the serious reloader. The Brass Smith Precision Funnel Set is made to be completely static free, no more powder clinging to surfaces which can happen with lightweight plastic funnels. The solid construction and quality of the Brass Smith Precision Funnel Set will be apparent in its first use. This is no "one size fits all" funnel, the Brass Smith Precision Funnel Set uses precision machined, caliber specific inserts to properly fit the case neck. The inserts can be quickly and easily installed by simply pushing them into place and then pulling them out when changing calibers. The Brass Smith Precision Funnel Set also comes with a padded storage case that neatly stores extra inserts when not in use. The funnel comes with inserts for 22, 243/6mm, 25/6.5mm, 270/7mm, 30 and 338 caliber rifle cartridges.

- Static Free aluminum die cast body and turned aluminum components
- Precision fit, CNC turned aluminum inserts for calibers 22 to 338
- Inserts are quick and easy to install and remove
- Convenient handle
- Includes padded storage case
- Inserts are laser marked for caliber identification

Brass Smith Precision Funnel Set . . . . . (#7752432)



**WARNING:** Cancer and Reproductive Harm  
[www.p65warnings.ca.gov](http://www.p65warnings.ca.gov)

**For pricing visit our website  
[www.lymanproducts.com](http://www.lymanproducts.com)**

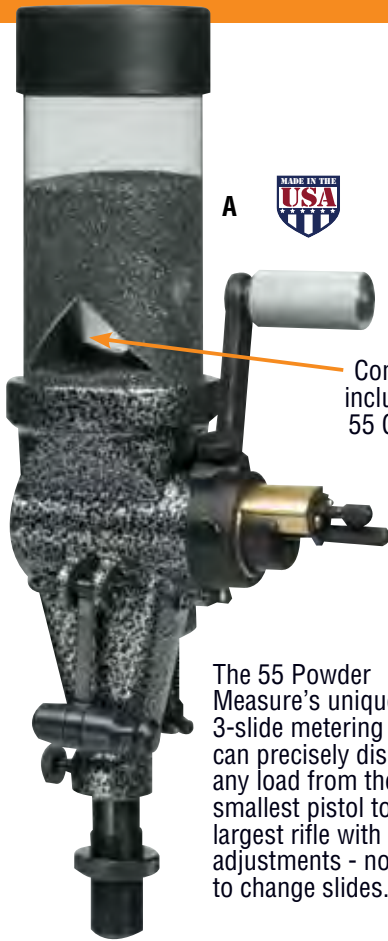

**A** Competition Powder Baffle included with Standard 55 & 55 Classic Powder Measure

The 55 Powder Measure's unique 3-slide metering bar can precisely dispense any load from the smallest pistol to the largest rifle with simple adjustments - no need to change slides.



**B**



**C**



**D**



**E**

The 55's unique rear mounting clamp maximizes mounting versatility.

**A. No. 55 Adjustable Powder Measure**

This powder measure dispenses charge after charge of powder with consistent accuracy to a fraction of a grain. The key to unflinching precision is the 55's unique three slide adjustable cavity. Extra fine adjustments of width and depth provide consistent charges with almost any powder. A 2400 grain reservoir resists chemical action and protects your powder from harmful light rays. An attached knocker assures a complete charge every time. Mount the 55 on your bench or any turret press. No funnel is required. Includes a 7/8" x 14 thread adapter for press or stand mounting.

No. 55 Measure (2 lbs., 10 oz.) . . . . . (#7767783)  
Optional 7000 grain reservoir (31/2 oz.) . . (#7998299)

**B. Competition Powder Baffle**

Consistent powder drops from the powder measure requires a uniform powder pressure on the rotor. The powder baffle maintains this consistent powder pressure even when the powder hopper is low. Included with all Lyman 55 Powder Measures.

Baffle . . . . . (#7767758)

**C. Powder Pal™ Universal Funnel Pan**

An innovative product for the reloader. The One Piece Combination Powder Pal Funnel Pan. This unique Funnel Pan saves time by saving one step during reloading. It is no longer necessary to put the funnel on the cartridge case and pour the powder in. Just pour it directly from the Funnel Pan into the case. Every reloader with an electronic scale will want to replace the powder pan with a time saving Powder Pal Funnel Pan. More innovations from Lyman. For use with electronic scales only. (US Patent # D568436)

Funnel Pan . . . . . (#7752433)

**D. Brass Smith Powder Measure Stand**

Lyman listened to the suggestions of our customers and have redesigned our powder measure stand. The new Brass Smith Powder Measure Stand can be mounted firmly to either a bench top or to a wall. Features standard 7/8"x 14 threads and will raise any measure high enough to easily position cases beneath the powder drop tube. Made of tough die cast aluminum.

Powder Measure Stand . . . . . (#7767788)

**E. 55 Classic Black Powder Measure**

Redesigned for both smokeless and black powder. The internal metering bars rotate in a non-sparking brass sleeve. A large non-static aluminum powder reservoir holds a pound of black powder. The unique three-slide adjustment bars are the key to consistent accuracy from small pistol charges to the largest rifle charges with accuracy to a fraction of a grain. Handles up to 200 grains. Mounts on the bench or directly on a press or powder measure stand and includes a 7/8 x 14 adapter.

55 Classic with 24" drop tube (#7767775)

**E-ZEE Flo™ Universal Powder Trickler**

Now the first powder Trickler that works with any reloading scale. Lyman's E-ZEE Flo accessory powder Trickler features an adjustable base that adapts to even that highest scale platform. Powder Trickler tube has an extension that allows use with electronic scales that have larger platform bases. The combination of the two adjustments allows use with any scale, mechanical or electronic.

Powder Trickler . . . . . (#7752477)

**E-ZEE™ Powder Funnel**



Redesigned with all of the latest cartridges in mind, the specially designed powder nozzle of this funnel handles everything from the smallest .22 up to the big .50 calibers. Including the Super Short Magnums.

Funnel (11/2 oz.) . . . . . (#7752431)



Full range of height adjustment handles any reloading scale.

**For pricing visit our website  
www.lymanproducts.com**

**WARNING:** Cancer and Reproductive Harm  
www.p65warnings.ca.gov



**Brass Smith™ 500 Metal Reloading Scale**

The Lyman Brass Smith 500 Metal Reloading Scale offers all of the features that serious reloaders are looking for. The Brass Smith 500 is built upon a sturdy aluminum body which reduces vibrations and ensures accuracy. The beam is double sided and the pan has two handles making it easy for right or left handed reloaders to use. In addition, the beam features black markings with a white background for easy reading throughout its 505 grain capacity. The scale also features magnetic dampening and precision ground knife edges for fast, smooth and accurate operation. Each scale is carefully calibrated at the factory and is accurate to plus or minus 1/10 grain.

Brass Smith 500 Reloading Scale . . . . . (#7752225)



(Shown Setup for Left-Hand Use)



**Brass Smith™ Powder Trickler**

The Lyman Brass Smith Powder Trickler was designed with the serious reloader in mind, combining all the features that they are looking for. It starts with a static free die cast aluminum body, which is adjustable for height. The base is machined out of a solid piece of steel, which gives the trickler plenty of weight and stability. The trickler also comes with an aluminum feed tube which can be set-up for a longer reach with the addition of the included feed tube extension. This allows it to be used with electronic scales with wider bodies, as well as mechanical beam scales. The large diameter knob on the feed tube gives you added precision and control when trickling powder out of the generously proportioned powder hopper. And finally, it has an attractive powder coat finish.

Brass Smith Powder Trickler . . . . . (#7752500)



**Brass Smith Powder Measure** 

Whether dropping charges for small pistol cases or large rifle cases, this measure gives consistent and accurate performance. The CNC machined steel metering cylinder features a micrometer adjustable thimble with reference lines so resetting the measure is easy. The reservoir is equipped with a powder baffle which maintains a consistent powder level for top accuracy. Includes two drop tubes to cover the full range of calibers.

- Micrometer adjustment
- Ambidextrous metering cylinder/handle
- Multiple handle angle positions for optimum comfort
- CNC machined steel metering cylinder
- Includes powder baffle
- Machined with 7/8" x 14 threads to fit all presses and stands

Brass Smith Powder Measure (#7767700)



**Deluxe Weight Check Set**



**Shooter's Weight Check Set**



**Scale Weight Check Sets**

Assures that scales provide accurate readings. Deluxe 10-piece set has 210.5 grains total weight. Shooters set totals 60.5 grains for normal powder use range.

- |                             |                               |
|-----------------------------|-------------------------------|
| <b>Deluxe set includes:</b> | <b>Shooters set includes:</b> |
| (1) 100 grain weight        | (2) 20 grain weights          |
| (1) 50 grain weight         | (1) 10 grain weight           |
| (2) 20 grain weights        | (1) 5 grain weight            |
| (1) 10 grain weight         | (2) 2 grain weights           |
| (1) 5 grain weight          | (1) 1 grain weight            |
| (2) 2 grain weights         |                               |
| (1) 1 grain weight          |                               |
| (1) .5 grain weight         |                               |

Deluxe Set . . . . . (#7752313)  
Shooters Set . . . . . (#7752314)

 **WARNING:** Cancer and Reproductive Harm  
[www.p65warnings.ca.gov](http://www.p65warnings.ca.gov)

**For pricing visit our website**  
[www.lymanproducts.com](http://www.lymanproducts.com)

**Gen5™**  
Touch-Screen  
Powder System



Extra Large,  
easy-to-read  
LCD Displays

Quick drain  
to change  
powders



**Gen6™**  
Compact  
Powder System



**Gen5™ Touch Screen Powder System**

Accurate to one tenth grain, The Gen5™ dispenses all types of smokeless powder at two grains per second. In addition, it features an auto repeat function that drops a precise charge each time the pan is reset.

Based on totally new digital technology that overcomes problems commonly experienced by older designs, the system is packed with additional state of the art improvements like fast, 3-minute warm-up, new anti-static and anti-drift technology and has sophisticated electronic shielding to resist interference from other electronic devices like cell phones, etc. The top of the line Gen5 adds the benefit of an extra large, easy-to-read LCD screen and touch screen controls, and a large, 1500-grain capacity. Plus, the quick drain powder reservoir speeds powder changes and the on-board memory stores up to 100 loads.

- New Touch-Screen Controls
- Stores up to 100 Loads in Memory
- Extra Large, Easy-to-read LCD Display
- New Fast, 3-Minute Warm-up
- Auto Repeat Function  
Automatically Dispenses Charges By Resetting Pan
- Quick-Drain to Change Powders
- New Electronic Interference Shield Resists Interference from Cell Phones, etc.
- New Anti-Static/Anti-Drift Technology
- Fast Operation - Dispenses 2 Grains per Second
- Accurate to 1/10 grain
- Handles All Types of Smokeless Powder

Gen5 Touch Screen Powder System . . . (#7750600)  
(115/230V)

**Gen6™ Compact Touch Screen Powder System**

The compact Gen6 design takes a minimum of bench space and offers unrestricted pan and touch screen access for both right- and left-hand users. Accurate to one tenth grain, The Gen6 dispenses all types of smokeless powder at two grains per second. In addition, it features an auto repeat function that drops a precise charge each time the pan is reset.

Based on totally new digital technology that overcomes problems commonly experienced by older designs, the system is packed with additional state of the art improvements like fast, 3-minute warm-up, new anti-static and anti-drift technology and both have electronic shielding to resist interference from other electronic devices like cell phones, etc.

- 1500 Grain Capacity
- New Touch Screen Controls
- New Compact Size - Uses 50% Less Bench Space!
- Auto Repeat Function Drops Charges Each Time Pan Is Reset
- Fast Operation - Dispenses 2 Grains Per Second
- Easy To Use Controls and Powder Pan Access for both Right and Left Hand Users
- New Anti-Static/Anti-Drift Technology
- New Electronic Interference Shield Resists Interference from Cell Phones, etc.
- Quick-Drain Powder System for Easy Powder Changes

Gen6 Touch Screen Powder System . . . (#7750550)  
(115/230V)

**Pocket Touch™ Digital Scale Set**

The Pocket-Touch 1500 offers full size performance in a very compact, portable design. The scale is just 2¼" x 4¼" x ¾" yet provides advanced touch screen controls and a full 1500 grain capacity. The scale comes with our patented Universal Funnel Pan, powder scoop and calibration weight. The unique Funnel Pan allows powder charges to be poured directly from the pan into the case. No need for a separate funnel. The scale has an easy to read, lighted display, is powered by (2)AAA batteries (included) and has an Auto Shut-off.

- Touch Screen Controls –  
On/Off, Tare, and Mode/Calibration keys
- 1500 grain capacity
- Universal Funnel Pan – combines a pour spout and a funnel end which accepts 20 caliber to 50 caliber cases
- Built-in, hinged dust cover
- Operates in grains or grams
- Handy powder scoop included
- 100 gram calibration weight included
- Easy to read, lighted, digital display

Pocket Touch Digital Scale Set. . . . . (#7750725)  
(115/230V)

**For pricing visit our website  
www.lymanproducts.com**

Which Scale Fits Your Reloading Needs?



Features a Handy Pop-Out Tray for Storage!



**Accu-Touch™ 2000 Electronic Reloading Scale**

The Accu-Touch 2000 reloading scale from Lyman offers many revolutionary features. It comes with a removable powder trickler that can be mounted on the scale in a right or left-hand position. Unlike most competitive scales, the Accu-Touch 2000 is accurate to within 1/10 of a grain over its full, extra large, 2000 grain capacity. It works in either grain or gram mode. The handy pop-out tray on the back stores all your accessories, and the fold back dust cover keeps the scale protected. Also includes calibration weight, Universal AC Adapter, and cleaning brush. It will also run on a 9V battery (not included).

- New Touch Screen Controls
- 2000 Grain Capacity
- New Anti-Drift Technology Assures Accuracy to 1/10 Grain
- Includes Removable Powder Trickler that Works in Right or Left-Hand Position
- Includes Powder Brush & Universal AC Adapter
- Handy Pop-Out Tray Stores Accessories
- Fold Back Dust Cover to Protect Scale
- Grains or Grams

Accu-Touch 2000 (115V/230V) . . . . . (#7751558)

**Pro-Touch™ 1500 Electronic Reloading Scale**

Lyman's Pro-Touch 1500 scale features a large, easy to use touch screen display with easy to read 7/8" tall numbers and full size control buttons. The Pro-Touch 1500 is accurate to +/- 1/10 grain over its full 1500 grain capacity. The dual spout powder pan allows for easy use by either right-handed or left-handed reloaders. The removable dust cover will protect the scale when not in use. The Pro-Touch 1500 will operate with either the supplied AC power adapter or with three AAA batteries (not included).

- Advanced Touch-Screen Technology
- 1500 Grain Capacity
- Accurate to 1/10 Grain
- Works in Grain or Gram Mode
- Removable Dust Cover
- Large, Easy to Read Digital Display with Full Size Control Buttons

Pro-Touch Desktop Reloading Scale . . . (#7750718) (115V/230V)

**Micro-Touch™ 1500 Electronic Reloading Scale**

The Micro-Touch 1500 has all the features of much larger models combined with state-of-the-art touch screen controls. Just 3.25" wide by 5.375" long and 1.25" tall with the dust cover in place, this scale has a full 1500 grain capacity. It is powered by an included AC adapter, but can also function on battery power when at the range or camp. The Micro-Touch 1500 also includes its own powder pan and calibration weight.

- New Touch Screen Controls
- 1500 Grain Capacity
- Accurate to 1/10 Grain
- Works in Grain or Gram Mode
- Fold Back Dust Cover
- Works with AC Adapter (incl.) or 3 AAA Batteries (not included)
- Large Easy-to-Read Digital Display

Micro-Touch 1500 (115V/230V) . . . . . (#7750700)

See our Check Weight Sets on page 7. Ideal for Electronic Scale Calibration.

For pricing visit our website [www.lymanproducts.com](http://www.lymanproducts.com)

Works with Lyman, RCBS,  
Lee & Redding  
Shellholders

Change primer size instantly  
and use any shellholder you  
already have.



Ergonomic shape  
designed to minimize  
hand fatigue.

Comes with large and  
small size primer tray/  
primer punch  
assemblies.



**E-ZEE Prime™ Hand Priming Tool**

Lyman has introduced a dramatic improvement in hand-held priming systems: The E-ZEE Prime Hand Priming Tool. The system works with any popular brand of shellholder and allows instant changeover between primer sizes. Lyman's E-ZEE Prime Tool includes two primer trays, each of which incorporate their own built-in large or small primer punch assembly. There are no small parts to fuss with or lose. Each tray has a built-in shut-off gate to keep primers in place during change-over. The reloader simply removes the snap-in-place lock collar and installs the correct sized primer tray and his standard shellholder as needed. Then the lock collar is snapped in place and the change-over is complete. The primer trays also function as a primer flipper to properly orient primers for seating.

In addition, the tool has a comfortable ergonomic design that works with the tool's optimized leverage system to reduce hand fatigue.

- Ergonomic shape designed to minimize hand fatigue
- Accepts all popular brands of standard shell holders, including Hornady, RCBS, Redding, and Lee Precision
- Plenty of leverage, yet provides needed "feel" for precision primer seating
- Integral primer tray and primer punch assembly - no small parts to lose
- Comes with large and small size primer tray/primer punch assemblies
- Primer tray has a built-in shut-off gate to prevent spilling primers
- Primer tray doubles as a flipper to orient primers for use

E-ZEE Prime Hand Priming Tool .....	(#7777810)
Replacement SMALL Tray .....	(#7777807)
Replacement LARGE Tray .....	(#7777808)

**Lyman Stuck Case Remover Kit**

The Lyman Stuck Case Remover will safely and easily remove stuck cases from sizing dies. Unlike other sets, all the tools that are needed are included. The set includes a unique dual purpose threaded cap that screws over the end of the die. This cap acts as both a drill guide and a guide for the pulling screw. An extra-long hex wrench is included which provides plenty of leverage when removing stuck cases and also doubles as a handle for the tap wrench.

- Set includes threaded cap, tap drill, 1/4-20 tap, hex screw, long hex wrench, and tap wrench.
- Everything needed is included in the set
- Included unique dual purpose threaded cap
- Long hex wrench provides plenty of leverage and doubles as a tap wrench handle
- Packed in an easy to display clam shell with full instructions

Stuck Case Remover Kit .....	(#7680350)
------------------------------	------------

**For pricing visit our website  
www.lymanproducts.com**

**MSR Precision Die System**



Lyman's MSR Die Sets are the only die sets engineered specifically for MSR ammo and are a must for anyone reloading for a modern sporting rifle.

- Ammo Checker cartridge "Go" gauge included with each set
- Available in 223/5.56, 6.8 Rem. SPC, 300 AAC Blackout, and 308 Winchester 3 die sets and 450 Bushmaster, 458 SOCOM and 50 Beowulf 4 die sets
- Small Base Size die for smooth chambering
- Separate Taper Crimp die for tight bullet grip
- Packed in a sturdy, clear cover storage case
- Black finish matches your favorite "black" rifle.

223 Rem 3-Die Set	.....	(#7690100)
6.8 Rem Special 3-Die Set	.....	(#7690102)
300 Blackout 3-Die Set	.....	(#7690104)
308 Win 3-Die Set	.....	(#7690106)
9mm 4-Die Set	.....	(#7690107)
450 Bushmaster 4-Die Set	.....	(#7690108)
458 SOCOM 4-Die Set	.....	(#7690110)
50 Beowulf 4-Die Set	.....	(#7690112)

**NEW FOR 2019**

MSR Die System 224 Valkyrie 3-Die Set	.....	(#7690101)
MSR Die System 9mm 4-Die Set	.....	(#7690107)



**Ammo Checker individual cartridge "Go" gauge and Free Shellholder included with each set**



**Creedmoor Neck Size Dies and Die Sets**



The 6.5 Creedmoor cartridge has established itself as one of the top performing long range rounds available. The new 6mm version is also quickly making its mark in precision long range shooting. To go along with our standard 6.5 Creedmoor die set, we are now offering an accuracy enhancing separate neck sizing die in this caliber. We are also introducing both a standard two die set and a neck sizing die for the 6mm Creedmoor.

- Available for 6.5 and 6mm Creedmoor
- Two die sets and separate neck sizing dies
- Top quality, all steel construction
- Neck sizers maintain fired case dimensions for perfect chamber fit and improved accuracy

6mm Creedmoor Neck Size Die Only	.....	(#7135128)
6.5 Creedmoor Neck Size Die Only	.....	(#7135130)
6mm Creedmoor 2 Die Rifle Set	.....	(#7452361)
6.5 Creedmoor Deluxe Rifle 3 Die Set	.....	(#7680252)

**WARNING:** Cancer and Reproductive Harm  
www.p65warnings.ca.gov



**For pricing visit our website  
www.lymanproducts.com**

## Multi-Expand Charge Die System

Designed to save the pistol reloader time. The hollow expanders allow you to expand the case and drop powder at the same time with your powder measure mounted on top. Fits all standard powder measures.

Includes expander body, hollow expanders for .32, 9mm, 38/.357, 10mm/40 S&W, .41, .44 and .45 plus a non-expanding universal powder drop tube.  
Multi-Expand (12 oz.) . . . . . (#7767901)

## Universal Decapping Die

The ideal die for decapping primers prior to case cleaning. **It has a unique one piece hardened steel decapping rod.** Perfect for military crimped in primers. Works on all calibers .22 thru .45 except .378 and .460 Weatherby. (Will not remove Berdan primers)

If you use a vibratory tumbler or sonic cleaner, this die provides the necessary first-step.  
Decapping Die (12 oz.) . . . . . (#7631290)

**The first step before ultrasonic cleaning.**

## Ram Prime Die System

Designed for sensitive one-at-a-time primer seating on top of a press. Works with all 7/8" x 14 threaded presses. Includes large and small primer punches.  
Ram Prime (10 oz.) . . . . . (#7728040)

## Tungsten Carbide Die

Pioneered by Lyman, these premium dies use a diamond hard, tungsten carbide ring to size straight walled cases. The T-C ring is so hard that clean cases can be smoothly sized without case lube. A real time saver.

## Neck Size Die

A Neck Size Die allows the reloader to properly size the case neck for optional bullet tension, while maintaining the fireformed dimension of the case body. Accuracy is increased when the case body closely fits into the chamber. The Neck Size Die includes a decapping rod and steel expander button.

## The Two-Step Neck-Expanding (M) Die

Improves accuracy of cast and jacketed bullet reloads. Doesn't stretch cases as does standard expander button. Extends case life. A "Must-Have" die for the cast or flat-base bullet user.

Many reloaders consider Lyman's Neck Expanding (M) Die a valuable tool for improving the accuracy of their reloads. The die's expander plug has two steps. (See illustration)  
(See charts pg. 14-15)

1) The first step expands the inside of the case neck to just under bullet diameter for precise case neck tension in the finished reload. (See Illus. A.)

2) The second step expands the case mouth to bullet diameter or slightly over. This allows the jacketed or cast bullet to be started perfectly centered in the case mouth and properly aligned with the axis of the case neck. (See Illus. B.)

NOTE: By adjusting the neck expanding plug slightly deeper, Step 2 also provides a slight flaring of the case mouth for reloaders using cast bullets. (See Illus. C.)



(See Die Charts pages 14-15 for complete listings)

## Classic Rifle Calibers

Cowboy shooting and the fine reproduction Sharps and other classic rifles have generated new interest in shooting the "obsolete" rifle calibers. But the custom reloading dies needed for these fine guns have been expensive and hard to find.

Lyman's Classic Rifle Die Sets have eliminated all the problems of costly custom dies. Lyman's die sets are available in the popular Sharps calibers listed below. These standard 7/8" x 14 3-die sets will fit all popular reloading presses and include Lyman's popular "M" 2 Step neck expanding die.

Caliber	Part No.	Caliber	Part No.
40-60	#7460507	45-90	#7460499
40-65	#7460490	45-120-3 1/4	#7460506
45-75	#7460509	56-50 Spencer	#7460497

## Black Powder Neck Size Dies

Classic rifle shooters rely on Lyman's neck size dies to retain the fireformed case dimensions. By not overworking the brass, these dies produce superior accuracy and extend the life of expensive shells. These neck size dies are available in the following sizes:

- 40 Cal. (40-65, 40-70 Sharps Straight) . . (#7135055)
- 45 Cal. Short (45-70, 45-90, 45-100) . . . (#7135057)
- 45 Cal. Long (45-110, 45-120) . . . . . (#7135059)

## Black Powder Taper Crimp Dies

BP cartridges require compression for proper ignition. This requires firm neck tension to hold the bullet without damage. The Taper Crimp Dies have a minimum taper that allows the reloader to apply the proper neck tension without damaging the bullet for best accuracy.  
40 Cal. (40-65, 40-70 Sharps Straight) . . (#7153120)  
45 Cal. Short (45-70, 45-90, 45-100) . . . (#7153124)

## Deluxe Neck Size Dies with Carbide Expander Button

The Lyman Deluxe Neck Sizing Die features a precision machined and hardened die body along with a super hard and slick carbide expander button. The expander button also free floats on the rod to allow it to self-center in the case neck and the slick button easily passes through the case neck. The result is a die that will reduce case stretching, increase case life and provide enhanced accuracy for the reloader. (see page 11)

## Taper Crimp Die

A Taper Crimp dies apply the proper taper crimp to pistol cases. Essential for proper function in auto pistols. Unlike some other die manufacturers, we feel that taper crimping is best done in a single purpose die station. Just add the taper crimp die to your current die set for a complete progressive reloading die set.

Each Taper Crimp die is heat treated to an RC50 minimum surface hardness. The interior is hand polished before and after heat treat to an 8 rms finish.

 **WARNING:** Cancer and Reproductive Harm  
www.p65warnings.ca.gov



# Two Sets in One!

Lyman gives you both full length and neck sizing in one set!



### Deluxe 3-Die Rifle Sets



Lyman's Deluxe 3-Die Rifle Sets give reloaders all the options they need to enhance the accuracy of their reloads and extend the life of their brass. By adding both a premium Carbide Expander Assembly and a Neck Sizing Die, Lyman has created two die sets in one. Neck sizing eliminates over-working the brass, dramatically extending case life.

The set includes:

- **Deluxe Carbide Expander Assembly**, with a free floating carbide sizing button, which smooths neck expansion by moving the button up the decapping rod to better use the press' leverage. It eliminates the need for inside neck lube.
- **Neck Sizing Die** which allows the case to retain the precise chamber dimensions of the individual rifle while avoiding excessive working of the brass.
- **Standard Full Length Sizing Die** for taking brass down to factory Dimensions.
- **Standard Bullet Seating Die**

Deluxe 3-Die Rifle Sets:

3 Die Rifle Set .204 Ruger . . . . .	#7680230
3 Die Rifle Set .22-250 . . . . .	#7680232
3 Die Rifle Set .223 . . . . .	#7680234
3 Die Rifle Set .243 . . . . .	#7680236
3 Die Rifle Set 6.5 x 55 . . . . .	#7680238
3 Die Rifle Set .270 Win. . . . .	#7680240
3 Die Rifle Set .30-06 . . . . .	#7680242
3 Die Rifle Set .308 . . . . .	#7680244
3 Die Rifle Set .300 Win. . . . .	#7680246
3 Die Rifle Set 7mm Rem. Mag . . . . .	#7680248
3 Die Rifle Set 338 Win. Mag . . . . .	#7680249
3 Die Rifle Set .338 Lapua . . . . .	#7680250

### Deluxe Carbide Expander/Decap Die Rod Complete



The Lyman Deluxe Carbide expander and decapping rod assembly features a super hard and slick carbide expander button with an adjustable positioning sleeve. The carbide button will offer easier extraction through case necks, which will help prevent case stretching and lessen case trimming. This will provide greater case life. The carbide button also floats free on the rod to allow for self-centering in the case neck. The button can be adjusted into two positions on the rod. This will allow it to be positioned for various cases of given calibers. It will also allow the user to adjust when the button pulls through the case neck so the press linkage can be positioned for better leverage. **Includes adapter for use with RCBS dies.**

- Super hard and slick carbide expander button
  - Fits all Lyman rifle sizing dies
  - Carbide button can be adjusted for height
  - Carbide free floats on the rod for self-centering in case necks
  - Replaceable decapping pin
- |                        |          |
|------------------------|----------|
| .22 Caliber . . . . .  | #7680300 |
| 6mm . . . . .          | #7680302 |
| 6.5mm . . . . .        | #7680304 |
| .270 Caliber . . . . . | #7680306 |
| 7mm . . . . .          | #7680308 |
| .30 Caliber . . . . .  | #7680310 |
| .338 Caliber . . . . . | #7680312 |

Includes Adapter for use with RCBS Dies



Already have a full length die set? The Deluxe Carbide Neck Size Die is available separately so you can upgrade your current dies for maximum accuracy potential. The Deluxe Carbide Expand and Decap Rod assembly can also be purchased individually to fit both Lyman and RCBS Rifle sizing dies.

### Deluxe Neck Size Dies with Carbide Expander Button



Lyman's Neck Size Die with carbide expander button enhances the value of any manufacturer's standard die set and eliminates the need to full-length resize and overwork the brass. It will also provide better accuracy - ask any target shooter! Use the full length sizing only when you need to.

The Lyman Deluxe Neck Sizing Die features a precision machined and hardened die body along with a super hard and slick carbide expander button. The expander button also free floats on the rod to allow it to self-center in the case neck and the slick button easily passes through the case neck. The result is a die that will reduce case stretching, increase case life and provide enhanced accuracy for the reloader.

Neck Size Dies with Carbide Button:

.204 Ruger w/Carbide Button . . . . .	#7135196
.223 w/Carbide Button . . . . .	#7135200
.243 w/Carbide Button . . . . .	#7135202
6.5 x 55 w/Carbide Button . . . . .	#7135204
.270 Win w/Carbide Button . . . . .	#7135206
.30-06 w/Carbide Button . . . . .	#7135208
.308 w/Carbide Button . . . . .	#7135210
.300 Win w/Carbide Button . . . . .	#7135212
7mm Rem. Mag w/Carbide Button . . . . .	#7135214
.338 Lapua w/Carbide Button . . . . .	#7135218

### Usage Chart

20 Cal.	22 Cal.	243 Cal.	6.5mm	270 Cal.	7mm	30 Cal.	338 Cal.
204 Ruger	222 Rem 223 Rem 22-250 220 Swift 223 WSSM	243 Win 243 WSSM 6mm Rem	6.5x55 260 Rem	6.8mm Rem 270 Win 270 WSM	7mm-08 7mm Mauser 7mm Rem Mag 7mm Rem Ultra 280 Rem	30-30 300 Savage 308 Win 30-06 300 Win Mag 300 WSM 300 Wea. Mag	338 Lapua 338 Win. Mag.

**WARNING:** Cancer and Reproductive Harm  
www.p65warnings.ca.gov

For pricing visit our website  
[www.lymanproducts.com](http://www.lymanproducts.com)



## Lyman® Precision Die Sets

Reloaders want volumes of reloads which deliver consistent quality. When it comes to precision, smoothness and versatility, Lyman Precision Dies are unsurpassed. Each sizing die is vented, polished, heat treated for toughness and receives a final micro-finish polish for extra smoothness. Lyman pistol die sets feature only solid, premium Tungsten Carbide sizing rings. They also include a one piece solid decapping rod made from hardened, heat treated tool steel that will not crack, even when depriming cases with crimped primer pockets.

Remember, Lyman dies fit all popular presses using industry standard 7/8" x 14 threads, including RCBS, Lee, Hornady, Dillon, Redding and others. Whether 2-, 3- or 4-die sets, these dies deliver round after round of the high performance ammo serious shooters demand.

### 3-Die Carbide Pistol Die Sets



Lyman was the originator of the Tungsten Carbide (T-C) sizing die and "Multi" concept with the addition of extra seating screws for pistol die sets. Combined with another Lyman original - the two step neck expanding die, our Multi-Deluxe Die Sets offer these features: a one piece hardened steel decapping rod and extra seating screws for all popular bullet nose shapes, and all steel construction.

### Premium Carbide 4-Die Sets



In addition to all the features of our three die sets, the Premium Carbide 4-Die Sets also include a separate taper crimp die. The 4-die set is perfect for those loading pistol calibers that headspace on the case mouth.



### Rifle 2-Die Sets



Set consists of a full length resizing die with decapping stem and neck expanding button and a bullet seating die. These die sets are the reloader's best choice for loading jacketed bullets in bottlenecked rifle cases. For those who load cast bullets, we suggest the addition of a neck expanding die, available separately.

### Rifle 3-Die Sets



Straight wall rifle cases require these three die sets consisting of a full length resizing die with decapping stem, a **two step neck expanding (M) die** (described on pg 12) and a bullet seating die. These sets are ideal for loading cast bullets due to the inclusion of the neck expanding die.

3-Die Sets ..... See Listing on pg 15

<b><i>Precision Pistol Dies</i></b>	Carbide 4 Die Set	Carbide 3 Die Set	Steel 3 Die Set	<b>Specialty Dies</b>		
				TC Carbide Size Die Only	Taper Crimp Die Only	Neck Exp. (M) Die
<b>Cartridge</b>						
5.7 x 28mm FN	—	—	7460486	—	—	—
.32 S&WACP/32 S&W Long	—	7680113	—	—	—	7342100
.327 Federal Mag	—	7680128	—	—	—	7342100
.380 Auto	—	7680112	—	—	—	7342081
.38 S&W	—	7680116	—	7597088	—	7341801
.38 Super Auto	—	7680116	—	7597088	—	7342081
9mm Luger	7680203	7680111	—	—	7153097	7342081
.38 Spec./357 Mag./357 Rem. Max	7680200	7680098	—	—	7153101	7341801
.40 Smith & Wesson/10mm Auto	7680207	7680118	—	—	7153116	7340833
.44 Mag. .44 Special/.445 Super Mag.	—	7680105	—	—	—	7340820
.45 A.C.P./45 Mag.	7680208	7680107	—	7596323	7153107	7340832
.45 Colt	—	7680110	—	—	7153107	7340832
.454 Casull	—	7680122	—	—	7153107	7340832
.460 Smith & Wesson	—	—	—	—	—	7340836
.500 Smith & Wesson	—	7680126	—	—	—	7340835

**For pricing visit our website  
www.lymanproducts.com**

**WARNING:** Cancer and Reproductive Harm  
www.p65warnings.ca.gov



***Special Purpose Dies***

Cartridge	Two Die Set	3-Die Set	Classic 3-Die Rifle Set	Deluxe 3-Die Rifle Set	Neck Size Die Only	Dlx.Neck Size Die Only	Rifle (M) Die	(M) Die Part Number
.204 Ruger	—	—	—	7680230	—	7135196	—	—
.22 Hornet	7452277	—	—	—	—	—	22 Hornet	7349058
.222 Remington	7452282	—	—	—	—	—	22 Short	7342097
.223 Rem. (5.56mm)	7457111	—	—	7680234	7135006	7135200	22 Short	7342097
.22-250	7452280	—	—	7680232	7135063	—	22 Short	7342097
.220 Swift	—	—	—	—	—	—	22 Long	—
6mm Creedmoor	7452361	—	—	—	7135128	—	—	—
.243 Winchester	7452283	—	—	7680236	7135015	7135202	24	7349007
6mm Rem. (.244 Rem.)	7452334	—	—	—	—	—	24	7349007
.25-06 Remington	—	—	—	—	—	—	25 Long	7349057
.25-20 Winchester	—	7469042	—	—	—	—	25-20	—
.260 Rem.	—	—	—	—	—	—	26	7349052
6.5 Creedmoor	7452362	—	—	7680252	7135130	—	26	7349052
6.5mmx55 Swedish Mau.	7452340	—	—	7680238	7135124	7135204	26	7349052
26 Nosler	7452358	—	—	—	—	—	26	7349052
.270 Winchester	7452289	—	—	7680240	—	7135206	27	7349009
.270 WSM	—	—	—	—	—	—	27	7349009
7mm Rem. Magnum	7455496	—	—	7680248	—	7135214	28	7349011
7mmx57 Mauser	—	—	—	—	—	—	28	7349011
7mm-08 Remington	7455646	—	—	—	—	—	28	7349011
28 Nosler	7452360	—	—	—	—	—	28	7349011
30 M1 Carbine	—	7460475	—	—	—	—	30 MI	7349004
.30-30 Winchester	7452299	—	—	—	—	—	30 S	7349003
300 AAC Blackout	7455547	—	—	—	—	—	30 MI	7349004
.300 Savage	—	—	—	—	—	—	30 S	7349003
7.62x39mm	7459110	—	—	—	—	—	30 S	7349003
.30-06 (7.62x63mm)	7452301	—	—	7680242	7135049	7135208	30 L	7349002
.308 Win. (.307 Win.)	7452298	—	—	7680244	7135047	7135210	30 L	7349002
.300 Weatherby Mag.	7455638	—	—	—	—	—	30 L	7349002
.300 Winchester Mag.	7455647	—	—	7680246	7135051	7135212	30 L	7349002
300 WSM	7455652	—	—	—	—	—	30 L	7349002
300 Rem Ultra Mag Short	—	—	—	—	—	—	30 L	7349002
7.62x54 Russian	7452291	—	—	—	—	—	30 L	7349002
.303 British	7452296	—	—	—	—	—	31 L	7349005
7.65mm Arg. Mauser	7458843	—	—	—	—	—	31 L	7349005
32-20 Winchester	—	7460484	—	—	—	—	31 S	7343006
.32 Winchester Spec.	—	—	—	—	—	—	32	7342073
.325 WSM	7452306	—	—	—	—	—	8mm	7349018
8mm x 57 Mauser	7452305	—	—	—	—	—	8mm	7349018
.338 Winchester Mag.	7452338	—	—	7680249	—	—	33	7340762
.338 Lapua Mag.	7452355	—	—	7680250	7135067	7135218	—	—
9.3 x 62	7459118	—	—	—	—	—	93 M	—
.375 H&H Magnum	7452316	—	—	—	—	—	37	7349015
.38-55 Winchester	—	7460494	—	—	7135126	—	37	7349015
.40-60 Win	—	—	7460507	—	—	—	40 S	—
.40-65	—	—	7460490	—	7135055	—	40L	—
.40-70 Sharps Straight	—	—	—	—	7135055	—	40L	—
.416 Rigby	7455449	—	—	—	—	—	—	—
.44-40 Winchester	—	7460495	—	—	—	—	44-40	7342102
.450 Marlin	—	7460524	—	—	—	—	45-70	7349053
.45-60 Win	—	—	—	—	—	—	45-60	—
.45-70 Government	—	7460496	—	—	7135057	—	45-70	7349053
.45-75 Win	—	—	7460509	—	—	—	45-60	—
.45-90	—	—	7460499	—	7135057	—	45-70	7349053
.45-100 Sharps	—	—	—	—	7135057	—	45-70	7349053
.45-110 Sharps	—	—	—	—	7135059	—	45-70	7349053
.45-120 Sharps	—	—	7460506	—	7135059	—	45-70	7349053
.50-70 Government	—	7660121	—	—	—	—	50-70	7342107
.50-90 Sharps	—	—	—	—	—	—	50-90	—
.56-50 Spencer	—	—	7460497	—	—	—	56-50	—

## Decapping Rods and Assemblies

Pistol rods are available in two styles; our original (threaded) rod unit with replaceable decapping pins and our one piece system. This decapping rod is a stronger one piece design with a hardened pin. All pistol dies are currently equipped with this rod. Rifle dies have an improved centering system requiring two different decapping rod lengths, 3.5" or 4.25", depending on caliber of the die. When ordering decapping assemblies, please indicate length or style required.

### Pistol

Decapping Rod Unit (with Replaceable Pin) . . . (#7129001)  
 One Piece Decapping Rod . . . . . (#7990524)

### Rifle

Decapping/Expanding Unit (state caliber) Call for pricing  
 Rod Only 3 1/2" (#7126011)  
 Rod Only 4 1/4" (#7126012)

### Universal Decapping Die Rod only

(#7990528)

### Decapping Pins

Package of 10 (#7837786)

### Special Die Accessories

#### Split-lock Ring

Popular steel split ring. Fits all 7/8" x 14 dies  
 (#7631304)

#### New Style -7/8" Hex Nut

Works with Bench Wrench (#7990119P)

### Die Boxes

Durable plastic box with snap lock hinged cover  
 For Die Set (#7980399)

### J to X Shell holder Adapter

For use with Lyman's older presses which used the older J-Type shell holders.  
 Converts press to use current X-Type shell holders  
 (#7095762)

### Special T Priming Punch

Required when using J to X shellholder adapter to seat primers in older style presses. Includes both large and small punches and sleeves.  
 (#7095763)

### 7/8 x 14 Adapter

For use in converting 310 dies for use in current 7/8 x 14 presses. Also mounts Model 55 Powder Measure to press.  
 (#7392036)

For information or to order  
**Lyman Die Parts, call Customer Service**  
**at 1-800-22-LYMAN or visit our website at**  
**www.lymanproducts.com**

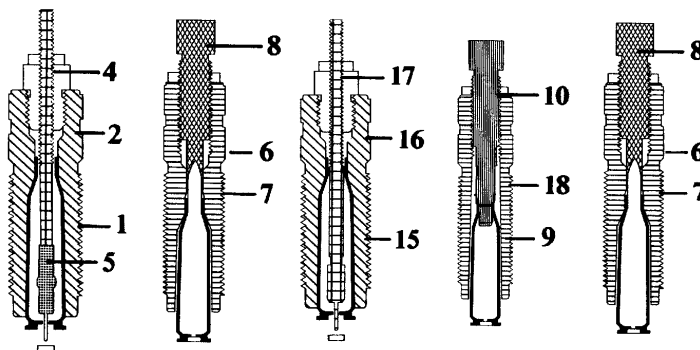

### Standard Rifle 2-Die and 3-Die Sets

1. Full Length Resizing and Decapping Die
18. Two Step Neck Expanding die (3-Die set)
6. Bullet Seating Die Complete

### Separate Die Parts: (State Caliber)

2. Die Body only (Sizing)
4. Decapping Rod only
5. Expanding Button only (2-Die Set)  
Decapping Pin Lock Nut (3-Die Set)
9. Die Body only (Expanding) (3-Die Set)
10. Expanding Plug Complete (3-Die Set)
7. Die Body only (Seating)
8. Bullet Seating Screw only ( State nose shape)  
Decapping Rod Complete (2-Die Set)  
Decapping Rod Complete (3-Die Set)

**Please Call  
Customer  
Service  
for Pricing  
and Information**

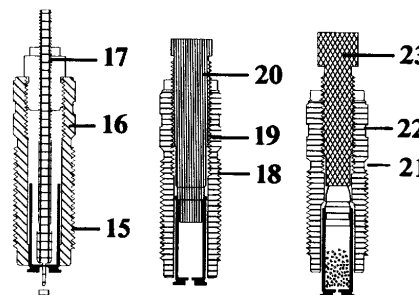

### Standard and Carbide Pistol 3-Die and 4-Die Sets

#### Separate Dies, Complete (State Caliber)

15. Full Length Resizing & Decapping Die (carbide)
18. Two-Step Neck Expanding Die
22. Bullet Seating Die complete Taper Crimp Die (4-Die Set)

#### Separate Die Parts: (State Caliber)

16. Die Body only (Sizing) Carbide
17. Decapping Rod Unit
19. Die Body only (Neck Expanding)
20. Expanding Plug Complete
22. Die body only (seating)
23. Bullet Seating Screw only (State nose shape)

**Please Call  
Customer  
Service  
for Pricing  
and Information**



RIFLE Caliber	Shell Holders		TrimmerPilots	
	No.	Item #	No.	Item #
.17 Remington	26	7738063	17	7821985
204 Ruger	26	7738063	20	7821981
.22 Hornet	4	7738043	22	7821987
.221 Fireball	26	7738063	22	7821987
.22/250	2	7738041	22	7821987
.222 Remington	26	7738063	22	7821987
.222 Remington Mag	26	7738063	22	7821987
.223 Remington	26	7738063	22	7821987
.223 WSSM	34	7738148	22	7821987
5.6x50R Mag	1	7738040	22	7821987
.243 Winchester	2	7738041	24	7821988
.243 WSSM	34	7738148	24	7821988
.244, 6mm Remington	2	7738041	24	7821988
25 WSSM	34	7738148	25	7821986
.25-20	10	7738049	25	7821986
.25-06 Remington	2	7738041	25	7821986
.250-3000 Savage	2	7738041	25	7821986
6.5 Creedmoor	2	7738041	26	7822013
6.5x55 Swedish	27	7738064	26	7822013
.260 Remington	2	7738041	26	7822013
26 Nosler	34	7738148	26	7822013
6.5x57 Mauser	2	7738041	26	7822013
6.5x57R Mauser	14B	7738054	26	7822013
6.8mm Remington	15	7738055	27	7821989
.270 Winchester	2	7738041	27	7821989
.270 WSM	34	7738148	27	7821989
7mm/08 Remington	2	7738041	28	7821999
7-30 Waters	6	7738045	28	7821999
7mm Remington Mag	13	7738052	28	7821999
7mm Weatherby Mag	13	7738052	28	7821999
7mm STW	13	7738052	28	7821999
7mm Rem. Ultra Mag.	13	7738052	28	7821999
7x57 Mauser	2	7738041	28	7821999
7x64 Brenneke	2	7738041	28	7821999
7x65R Brenneke	14B	7738054	28	7821999
.280 Rem (7mm Express)	2	7738041	28	7821999
28 Nosler	34	7738148	28	7821999
.30-30	6	7738045	30	7821991
.300 AAC	26	7738063	30	7821991
.300 Savage	2	7738041	30	7821991
.307 Winchester	6	7738045	30	7821991
.308 Winchester	2	7738041	30	7821991
.30-06	2	7738041	30	7821991
.300 WSM	34	7738148	30	7821991
.300 Winchester Mag	13	7738052	30	7821991
.300 Remington Ultra Mag.	13	7738052	30	7821991
.300 Remington Ultra Mag SA	13	7738052	30	7821991
.300 Weatherby Mag	13	7738052	30	7821991
7.62x39	3	7738042	30	7821991
.32-20	10	7738049	31	7821992
7.65 Argentine Mauser	2	7738041	31	7821992
7.62x54 Russian	17	7738057	31	7821992
.303 British	7	7738046	31	7821992
.32 Winchester Special	6	7738045	32	7821994
8x57 Mauser	2	7738041	8mm	7821995
8x57 JS	2	7738041	8mm	7821995
7.9x57	2	7738041	8mm	7821995
8x57 JRS	14B	7738054	8mm	7821995
8mm Remington Mag	13	7738052	8mm	7821995
325 WSM	34	7738148	8mm	7821995
.338 Winchester Mag	13	7738052	33	7821996
.338 Remington Ultra Mag.	13	7738052	33	7821996
.338 Lapua Mag	38	7738152	33	7821996
.35 Remington	2	7738041	35	7822001
.356 Winchester	6	7738045	35	7822001
.358 Winchester	2	7738041	35	7822001
.35 Whelen	2	7738041	35	7822001
9.3mm x 62	2	7738041	36	7822009
.375 Ruger	13	7738052	37	7822002
.375 Winchester	6	7738045	37	7822002
.38-55	6	7738045	37	7822002
.375 H&H Magnum	13	7738052	37	7822002
.375 Rem. Ultra Mag.	13	7738052	37	7822002
.40-60 Win	17	7738057	40	7822012
.40-65	17	7738057	41	7822004
.416 Rigby	17	7738057	416	7822014
.44-40 Winchester	14B	7738054	44A	7822005
.444 Marlin	14B	7738054	44	7822006
.450 Marlin	13	7738052	45	7822008
.45-60, .45-70 & 45-90	17	7738057	45	7822008
.45-100	17	7738057	45	7822008
.45-110	17	7738057	45	7822008
.45-120	17	7738057	45	7822008
.50-70 Government	22	7738062	—	—
.50-90	22	7738062	—	—
56-50 Spencer	22	7738062	50B	7821982

Shellholders

Detachable Shellholder

Precisely machined to insure perfect case fit. Fits all popular presses. See shellholder reference chart on this page. Detachable Shellholder (3 oz.) select number

J to X shellholder adapter ..... (#7095762)

Allows use of X Shellholder with older Lyman presses that used J-Type Shellholders.

Individual Pilots

Nine Pilot Multi-Pack ..... (#7822202)

Includes nine of the most popular pilots: 22, 24, 27, 28/7mm, 30, 9mm, 35 (38/357), 44 and 45A.

PISTOL Caliber	Shell Holders		Trimmer Pilots	
	No.	Item #	No.	Item #
5.7 x 28mm FN	35	7738149	22	7821987
7mm TCU	26	7738063	28	7821999
.30 Luger	12	7738051	30	7821991
.30 Mauser	12	7738051	30	7821991
.32 ACP	23	7737486	31	7821992
.32 S&W Long	9	7738048	31	7821992
.32 H&R Mag	9	7738048	31	7821992
.327 Fed Mag	9	7738048	31	7821992
.38 Super Auto	12	7738051	9mm	7821997
9mm Luger	12	7738051	9mm	7821997
9 x 23mm	12	7738051	9mm	7821997
.380 Auto	26	7738063	9mm	7821997
.38 S&W	21	7738075	35	7822001
.38/.357Mag	1	7738040	35	7822001
.357 Remington Maximum	1	7738040	35	7822001
9mm Makarov	12	7738051	36	7822009
.40 S&W & 10mm	15	7738055	39	7822003
.41 Mag	30	7737492	41	7822004
.41 Action Express	12	7738051	41	7822004
.44 Mag/Spl./44 Russian	7	7738046	44	7822006
.44-40 Winchester	14B	7738054	44A	7822005
.45 ACP/.45 Win Mag	2	7738041	45A	7822007
.45 Schofield	14B	7738054	45A	7822007
.45 Colt	11	7738050	45A	7822007
.454 Casull	11	7738050	45A	7822007
.460 S&W	7	7738046	45A	7822007
.475 Wildey	2	7738041	47	7822010
.480 Ruger	17	7738057	47	7822010
.50 Action Express	7	7738046	50A	7821983
.500 S & W	17	7738057	50A	7821983

Shellholder Set

We have selected the 12 most used shellholders which fit the most popular pistol and rifle calibers and place them into a handy compartmented storage box. This set includes shellholders #1, 2, 6, 7, 11, 12, 13, 14B, 15, 17, 22 and 26 which fit well over 75 different calibers. (See reference chart for calibers). Best of all, this will save 60% over buying individual shells.

Shellholder Set with Box (12 oz.) ..... (#7712110)



Best Value!  
Save 50% Over  
individual  
Purchases

12 piece  
Shellholders Set



For pricing visit our website  
www.lymanproducts.com

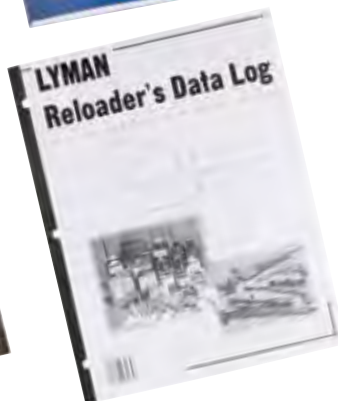
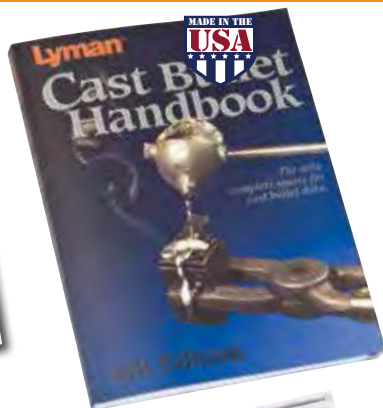

**AR Reloading Handbook**

The first reloading handbook dedicated exclusively to the most popular modern semi auto rifle and it's many variants. This comprehensive handbook provides the AR shooter with reloading data for nearly all AR based calibers. In addition the standard .223, also covered are: 6.8 Rem, 300 AAC, 7.62x39, 450 Bushmaster, 50 Beowulf and more.

Interesting articles by well known and popular firearms journalists are also included. These cover such areas as "Reloading for Suppressors" and "Cartridge Interchangeability". Finally all this AR data is presented in a full size, easy-to-use 8 1/2" x 11" format. This is required reading for any AR shooter.

AR Reloading Handbook ..... (#9816045)

**Cast Bullet Handbook, 4th Edition**

The first new cast bullet data manual in 30 years contains data using the latest and most available components for bullet casters. In addition to data for Lyman's entire line of rifle and pistol moulds, the Cast Bullet Handbook includes data for selected moulds from other manufacturers. Like Lyman's other popular handbooks, this large edition covers valuable "how-to" editorial as well as important articles by acknowledged authorities in the field.

Cast Bullet Handbook ..... (#9817004)

**Lyman Black Powder Handbook, 2nd Ed.**

Edited by Sam Fadala, this is the most comprehensive black powder manual available. It includes thousands of pressure tested loads, along with a large assortment of round balls, conicals and sabots. Down range velocities and energies are also given for each load. Topics also covered include: choosing your muzzleloader, building the best loads, propellants, ignition, maintenance and black powder cartridges. There are also hundreds of pressure tested black powder cartridge loads for larger calibers.

Black Powder Handbook ..... (#9827100)

**Lyman Pistol & Revolver Handbook, 3rd Ed.**

The most complete handgun reloading data, encompassing all major brands of bullets, powders and primers. More than just data charts, this handbook also contains a number of captivating feature articles by well-known writers covering such popular subjects as: Cowboy Action shooting, loading for big bore revolvers and handgun varmint hunting.

Pistol & Revolver Handbook, 3rd Ed. .... (#9816500)

**The Lyman Shotshell Handbook, 5th Ed.**

This is the most complete and up-to-date shotshell reloading manual available. It covers cases, wads, and primers currently offered by all leading manufacturers in all gauges from .410 to 10 gauge. Non-Toxic Data Section covers steel, bismuth and Hevi-Shot, plus complete how-to load instruction. Slug and Buckshot Loads are covered too, plus a how-to-load section.

Shotshell Reloading Handbook ..... (#9827111)

**Lyman Reloading Data Log**

The Lyman Reloading Data Log is a must for shooters who reload. The large, easy-to-use format has plenty of room to enter all important data such as bullet, powder, primer, case, firearm used, plus size, velocity, conditions and several lines for comments on your reloads. Large 8 1/2" x 11" size. 50 pages per log.

Reloading Data Log (10 oz.) ..... (#9847261)

**Reloading and Cast Bullet Users Guide**

This booklet is filled with complete information on getting started in Reloading and Bullet Casting. It also includes detailed product instructions and parts drawings for Lyman presses, trimmers, scales, powder measure and tumblers.

Users Guide (4oz) ..... (#9837283)

**Lyman Load Data Series**

Lyman's load data is now available by caliber or category in handy books. The Load Data Books are ideal for the reloader who only wants to reload for select calibers. Like all Lyman Handbooks, these cover all popular brands of powder, primers and bullets, even cast bullets. They are the perfect way to survey which components and loads to select before reloading a new cartridge. Lyman Load Data Booklets include:

**12 Gauge** ..... (#9780000)  
12 ga. 23/4" Target & Field Loads

**20, 28, 410 Gauge** ..... (#9780002)  
20ga. 23/4", 28ga 23/4", 410 Bore 3", 410 Bore 2 1/2" Lead Shot Data

**Semi-Auto Pistol** ..... (#9780004)  
380 Auto, 9mm Luger, 40 S&W, 45 ACP

**Popular Revolver** ..... (#9780006)  
38 Spec, 357 Mag, 44 Mag, 45 Colt

**Popular Varmint Calibers** ..... (#9780008)  
204 Ruger, 222 Rem, 223 Rem, 22-250 Rem

**270, 7mm Calibers** ..... (#9780012)  
270 Win, 7mm-08 Rem, 7mm Mauser, 7mm Rem Mag, 7mm WSM

**30 Caliber** ..... (#9780014)  
30-30 Win, 308 Win, 30-06 Springfield, 300 WSM, 300 Win Mag

**Old Military Calibers** ..... (#9780016)  
30 m1, 7.62x39mm Rus, 7.62x54Rmm Rus, 7.65 Arg.Mau, 303 Brit, 8mm Mau

**338, 8mm Calibers** ..... (#9780018)  
325 WSM, 338 Fed, 338 Win Mag, 338 Lapua

**Classic American Rifle Calibers** ..... (#9780020)  
38-55 Win, 40-65 Win, 40-70 Sharps Str., 405 Win, 45-90 Win Mag, 45-100 Sharps, 45-110 Sharps, 45-120 Sharps

**Big Bore Rifle Calibers** ..... (#9780022)  
375 H&H Mag, 416 Rigby, 416 Wea, 458 Win, 460 Wea.

**For pricing visit our website  
www.lymanproducts.com**

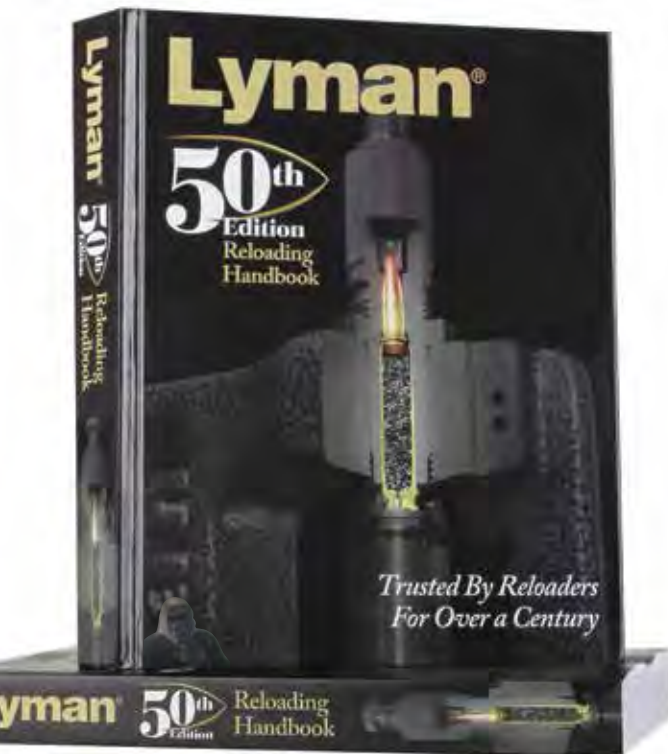

**Lyman 50th Edition Reloading Handbook**

For more than a century, the Ideal and then Lyman handbooks have been the reloaders' core resource for proven reloading data. Lyman pioneered the concept of delivering a wide range of components to use in generating safe, accurate loads. As reloading has grown, so have Lyman handbooks, with each edition eclipsing its predecessor, growing in size and quantity of data and becoming an important addition to every serious reloader's library.

Lyman's 50th Anniversary Edition continues our heritage as being the proven source for reloading data. Lyman handbooks have always used the widest selection of cartridges, bullets and powder from all the major manufacturers. This 50th Edition continues our tradition of being the only data source using multiple brands throughout our data.

- New Cartridges Included: 17 Hornet, 6.5 Grendel, 6.5 Creedmoor, 6.5-284, 26 Nosler, 28 Nosler, 300 Blackout, 300 RCM, 338 RCM, 450 Bushmaster, 458 SOCOM, 50 Beowulf
- Largest Selection of Bullets: Barnes, Hornady, Remington, Sierra, Speer, Swift and Winchester plus full selection of Cast Bullets
- Wide Range of Popular Powders: Accurate, Alliant, Hodgdon, IMR, Ramshot, VihtaVuori and Winchester
- Feature Articles by Top Gun Writers and Firearm Industry Experts
  - "Barrels – Looking into the Unknown" by Ryan Newport
  - "Advanced Case Preparation Techniques" by John Haviland
  - "What is a Ballistic Coefficient and How Do You Use It?" by Dave Emary and Lane Pearce
  - "The History of Modern Lyman Handbooks" by Ed Matunas, Ken Ramage and Tom Griffin
- New Full Color Edition - The 50th Anniversary edition is our first reloading handbook produced in full color

50th Reloading Handbook Hardcover ..... (#9816050)  
 50th Reloading Handbook Softcover ..... (#9816051)

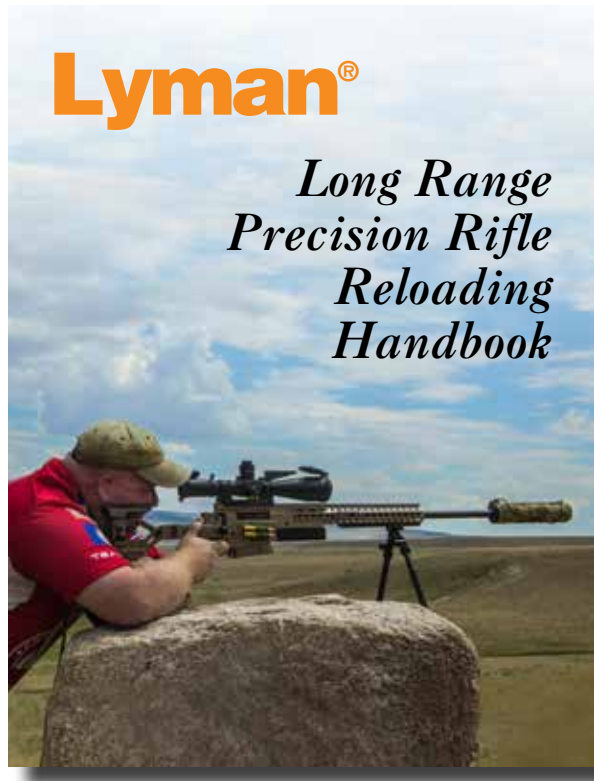

**Long Range Precision Rifle Reloading Handbook**

One of the fastest growing shooting sports in the country is precision long range rifle shooting. The Precision Rifle Series and Extended Long Range matches are being held all over the country and industry leaders are producing numerous rifles, scopes, bi-pods, and other accessories for this exciting sport. One area that has been lacking however is reliable reloading data, until now!

- Specific data for precision long range cartridges including: 223 Rem., 6mm Dasher, 6x47 Lapua, 6XC, 6mm Creedmoor, 243 Win., 6.5x47 Lapua, 6.5 Creedmoor, 260 Rem., 6.5-284 Norma, 308 Win., 300 Win Mag, 300 Norma Mag and 338 Lapua.
- Target bullets from Berger, Lapua, Sierra and Hornady
- Includes pressure and velocity data
- Articles by top PRS shooters and industry experts
- Printed in full color format

Long Range Reloading Handbook ..... (#9816060)

**6.5 CREEDMOOR**

**Ballistics Data Table:**

Bullet	Velocity (ft/s)	Drop (in)	Wind (in)
140 gr. Berger Hybrid	2800	1.5	1.0
140 gr. Hornady	2800	1.5	1.0
140 gr. Sierra	2800	1.5	1.0
140 gr. Swift	2800	1.5	1.0
140 gr. Winchester	2800	1.5	1.0

**Powder Charge Table:**

Rifle Model	140 gr. Hybrid	140 gr. Hornady	140 gr. Sierra	140 gr. Swift	140 gr. Winchester
Remington 700	42.0	42.0	42.0	42.0	42.0
Winchester 700	42.0	42.0	42.0	42.0	42.0
Sierra 700	42.0	42.0	42.0	42.0	42.0



**Cyclone™ Rotary Tumbler**

The Cyclone Rotary Tumbler takes brass cleaning to a whole new level. The rotary tumbling action combined with the stainless steel media and liquid cleaning solution gets brass cleaner on the outside than vibratory tumbling methods. The small stainless pins easily slip inside cases and into primer pockets to provide superior cleaning action in these areas. Something that a vibratory tumbler will not do! The large capacity drum holds up to 1000 pieces of .223 brass and features a rubber lining to protect brass and greatly reduce noise during operation. A built in timer in the base can be set to run from 0 to 3 hours, shutting off automatically. The drum features a large end cap to allow easy loading and unloading.

In addition, the tumbler comes with a pair of unique sifter pans that makes separating pins from the cases a breeze! Simply empty the tumbler into the stacked pans. The first pan catches the brass, while the second fine screen pan catches the pins. Five pounds of stainless media pins and a sample packet of Brass Cleaning Solution are also included.

- Cyclone Rotary Tumbler 115V ..... (#7631550)
- Cyclone Rotary Tumbler 230V ..... (#7631551)

**The following items are INCLUDED with the Lyman Cyclone™ Rotary tumbler, but also available separately for use with other tumblers.**

- Dual Sifter Set ..... (#7631314)
- Stainless Steel Cleaning Media 5lbs ..... (#7631375)



The Cyclone™ Rotary Tumbler has everything you need to get started: it includes 5 pounds of stainless steel media pins and sample packet of cleaning solution, as well as the unique Dual Sifter System.



**Stainless Steel Pin Magnet**

Lyman's Stainless Steel Pin Transfer Magnet is the answer for separating your cases from the media pins used in rotary tumblers. Simply pass the magnet over the mixture of cases and pins and the pins will be pulled out and grabbed by the magnet. To release the pins, just pull up on the handle. The large diameter, strong magnet will collect many pins in a single pass. Fast, convenient and simply to use! A perfect companion for the Lyman Cyclone Rotary Tumbler and other brands of rotary tumblers.

- Stainless Steel Pin Magnet ..... (#7631370)

**Rotary Tumbler Cleaning Solutions**

- Case Cleaning Solution 4oz ..... (#7631711)
- Case Cleaning Solution 16oz ..... (#7631705)
- Case Cleaning Solution 32oz ..... (#7631714)



Lyman's Dual Sifter System separates pins from cases better than any other system. The first pan catches the brass, while the second pan catches the pins. Separate cases and media, all in one step!



**Cyclone® Case Dryer**

The perfect companion to any Ultrasonic or Rotary cleaning system. No longer will it be necessary to have to wait days for your brass to air dry! The forced heated air circulation of the Cyclone will dry your brass inside and out within an hour or two, with no unsightly water spots. The individual trays can keep your different caliber cases separate. Additionally, the dryer can also be used for gun parts that have been ultrasonically cleaned.

- Holds up to 1000 – 223 cases or 2000 – 9mm cases
- 3 hour timer
- Recessed handles on trays for easy loading and unloading
- Fast drying time
- Works with brass cases or gun parts
- Durable and long-lasting ABS trays

Cyclone® Case Dryer 115V ..... (#7631560)  
 Cyclone® Case Dryer 230V ..... (#7631561)  
 (Note: 230V model contains a universal plug to work in most countries.)



For pricing visit our website  
[www.lymanproducts.com](http://www.lymanproducts.com)



**TurboSonic® 2500**

- Heated tank delivers Superior Ultrasonic Performance and more efficient action.
- Processes up to 900 9mm cases in less than 15 minutes
- Cleans cases inside & out, including primer pockets
- TurboSonic® Case Cleaning Solution is specially formulated for cleaning Brass Cases.
- Separate Gun Parts Solution for Steel & Stainless Steel Parts.
- All solutions can be used with any Ultrasonic Cleaner.

TurboSonic 2500 (115V) ..... (#7631700)  
 TurboSonic 2500 (230V) ..... (#7631702)  
 Replacement or Extra Basket ..... (#7631710)

**TurboSonic® 6000**

- 6.3 quart tank (12.8"x8"x3.9") fits the biggest handguns or multiple pistol frames.
- Cleans up to 1300 9mm cases or 4 handgun frames.
- Powered by two industrial grade ultrasonic transducers.
- Tank has a built-in drain and hose for easy solution changes.
- Comes with a large plastic parts basket with convenient handles.
- Heated tank for optimum cleaning performance.
- 2 color LED display with 5 timed cleaning cycles.

TurboSonic 6000 (115V) ..... (#7631725)  
 Replacement or Extra Basket ..... (#7631708)

**TurboSonic® Cleaning Solutions & Accessories**

Cleaning with ultrasonics requires the correct solution for the specific cleaning application. Lyman has partnered with a renowned chemical research team to develop a broad line of superior solutions for use with any of today's new ultrasonic cleaners. Our TurboSonic Case Cleaning Solution is formulated to deliver superior results - inside and out.

Our Gun Parts Solution is the perfect choice for steel and stainless steel parts such as barrels, cylinders or other parts and tools.

For high volume gun cleaners, we have expanded our line of ultrasonic solutions with our new gallon size TurboSonic Steel Cleaner. Follow that up with Lyman Gun Lube, available in handy 1 gallon or even 5 gallon cans. The Steel Cleaning Solution and the Case Cleaning Solution are also available in 4oz, 16oz and 32oz bottles.

Ultrasonic cleaners are also great for cleaning jewelry! For the Sportsman who also wants to use a Lyman TurboSonic to clean fine jewelry or other valuable items, Lyman offers a special 16oz jewelry cleaning solution.

Model	Tank Size	Capacity	Timer	Heater	Drain Valve	Fits 9mm # Cases	Fits 223 # Cases	Fits 30-06 # Cases
TS-2500	9.84 x 5.90 x 3.15	2500ml (2.6qt)	5 Pre-set Settings	Yes	No	900	400	250
TS-6000	12.7 x 8.0 x 3.9	6000ml (6.3qt)	1-30 min. full range	Yes	Yes	1300	650	400



**Brass Baggies**

Allows you to keep different batches of cases separate during the cleaning process. Use inside Ultrasonic machine while cleaning.

Brass Baggies (12 pack) (#7631391)

- TurboSonic Gun Lube 1 Gallon ..... (#7631735)
- TurboSonic Steel Cleaning Sol. 1 Gal. ⚠ (#7631736)
- Case Cleaning Solution 4oz ..... ⚠ (#7631711)
- Case Cleaning Solution 16oz ..... ⚠ (#7631705)
- Steel Cleaning Solution 16oz ..... ⚠ (#7631707)
- Case Cleaning Solution 32oz ..... ⚠ (#7631714)
- Steel Cleaning Solution 32oz ..... ⚠ (#7631715)
- Jewelry Cleaning Solution 16oz ..... ⚠ (#7631709)
- TurboSonic Measuring Cup ..... (#7631716)

**⚠ WARNING:** This product can expose you to chemicals including Diethanolamine or Methanol, which are known to the State of California to cause cancer and/or birth defects or other reproductive harm. For more information go to [www.p65warnings.ca.gov](http://www.p65warnings.ca.gov)

**For pricing visit our website  
[www.lymanproducts.com](http://www.lymanproducts.com)**



**OUR LARGEST, MOST POWERFUL  
ULTRASONIC CLEANER.**

*Ten Powerful Ultrasonic Transducers Make This  
Machine Ideal for Industrial Use*

**Overall Dimensions**  
L 38½" W 10¾" H 14"  
**Tank Dimensions**  
L 35¾" W 8" H 6¼"

*Handy built-in  
spout extends  
for pouring  
with no mess!*



**TurboSonic® Barrel & Gun Parts Lube**

Specifically formulated for ultrasonic use right out of the bottle, TurboSonic Gun Lube displaces moisture and penetrates all the hard to reach areas of any part making it ideal for use after ultrasonic cleaning. Formulated for superior firearms lubrication and protection, the lube leaves a dry protective, lubricating film and can be reused repeatedly.

TurboSonic Gun Lube 1 Gallon . . . . . (#7631735)

**Now Available in 5-Gallon Can!**

- Handy 5 Gallon Container for volume users - Ideal for Power Pro users!
- Pouring Spout extends for easy pouring with no mess  
TurboSonic Gun Lube 5 Gallon . . . . . (#7631754)

**TurboSonic® Steel Cleaner** ⚠

Designed for high volume cleaning and lubrication, the new gallon containers of TurboSonic solutions give the gunsmith, armorer or advanced hobbyist plenty of cleaning concentrate.

TurboSonic Steel Cleaning Solution 1 Gallon (#7631736)

**⚠ WARNING:** This product can expose you to chemicals including Diethanolamine or Methanol, which are known to the State of California to cause cancer and/or birth defects or other reproductive harm. For more information go to [www.p65warnings.ca.gov](http://www.p65warnings.ca.gov)



*The Power Pro Accessory Lube Tank delivers ultrasonic lubrication  
without draining the cleaning solution*

**TurboSonic®  
Power Professional**

Designed for high volume cleaning or for larger than normal items, the TurboSonic Power Pro's 34.75" heated stainless steel tank can easily handle most barreled actions, upper receivers, as well as several handguns at a time. The powerful industrial transducers aggressively deep clean and degrease items, both inside and out. In fact, the Power Pro is such an effective cleaner that Lyman recommends that cleaned parts immediately be ultrasonically treated with Lyman's TurboSonic Gun Lube. Changing from cleaning to lubrication is easy with the built in drain system. Lyman now offers both cleaning concentrate and parts lubricant in gallon containers.

For complete control of the process, the Power Pro has both a timer and an adjustable heat control. Temperatures up to 175 degrees can be selected.

TurboSonic Power Pro (115V) . . . . . (#7631734)  
Replacement or Extra Basket . . . . . (#7631745)

**Power Pro Accessory Lube Tank**

Now, users of Lyman's industrial strength Power Pro ultrasonic cleaner can easily and completely lube parts without draining the cleaning solution from the unit. This rugged, stainless tank is designed to sit in the Power Pro's cleaning tank which remains filled with cleaner. The unit's powerful ultrasonic action is transmitted through the cleaning solution into the accessory tank filled with lube. No tank draining or cleaning needed.

- Allows firearms to be lubricated without draining cleaning solution
  - Side brackets support the accessory tank allowing it to sit in the cleaning solution, transferring the ultrasonic action to the lube
  - Tough, welded metal construction
  - Large handles make moving the tank easy
  - Huge time savings when cleaning multiple firearms
- Power Pro Accessory Lube Tank (#7631739)

**For pricing visit our website  
[www.lymanproducts.com](http://www.lymanproducts.com)**

*The Industry Leader in Brass Cleaning*



**A. Turbo® 600**   
**A balance of capacity, power & economy**  
 For the reloader who processes smaller volumes of cases but wants maximum utility and versatility. This model can not only polish 175 .38 Special cases, but can also polish rocks and heavier items. The Turbo® 600 models have convenient, see-through tops.  
 Turbo 600 Tumbler 115V ..... (#7631306)

**B. 2200 Auto-Flo™ Tumbler**   
**The Original Auto-Flo™**  
 The 2200 features a high strength “Ultra-Thick” Roto Molded bowl which will last as long as you own your tumbler. The 1.5 gallon capacity is ideal for the large volume user and can clean 750 .38 Special cases in one cycle. The 2200 also features a clear see-thru lid for inspecting cases during cleaning. A media drain pan is also included.  
 2200 Auto-Flo 115V ..... (#7631601)  
 2200 Auto-Flo 230V ..... (#7631611)

**I. Auto-Flo™ Conversion Kit**   
 Auto-Flo conversion systems can give your standard tumbler the “Auto-Flo Advantage”. Works on Lyman Tumblers and most competitive models of similar bowl size. All systems include bowl, lid, Auto-Flo drain base and media dump pan.  
 600/1200 Auto-Flo Conversion Kit ..... (#7631636)

**C. & D. 2500 Pro Magnum Tumbler**   
 Lyman’s Pro Magnum Tumbler is designed for the high volume reloader, and high volume reloaders are always looking for value. The two gallon capacity bowl is engineered to deliver powerful cleaning action even at full capacity. Handling up to 1000 .38 Special cases at a time, the heavy-duty motor and advanced drive system deliver fast cleaning and long life. For maximum convenience, Auto-Flo models are also available.  
 2500 Pro Magnum 115V ..... (#7631692)  
 2500 Pro Magnum Auto-Flo 115V ..... (#7631697)  
 Spare Bowl for 2500 Pro Mag ..... (#8077020)  
 Spare Lid for 2500 Pro Mag ..... (#8077310)

**E. 1200 Auto-Flo™ Tumbler**   
**The Turbo that started the revolution in case cleaning.**  
 The 1200 Auto-Flo has the same capacity as the original 1200 but features the Auto-Flo self separating system. When cases are clean, the drain plug is removed and the media flows through the tumbler into the drain pan (included with all Auto-Flo tumblers).  
 1200 Auto-Flo 115V ..... (#7631630)  
 1200 Auto-Flo 230V ..... (#7631632)

*Converts Regular Tumblers to Auto-Flo™!*



**The Auto-Flo™ Advantage**  
 The ultimate in case cleaning convenience, Lyman’s Auto-Flo Tumblers automatically separate clean cases from media using the unit’s normal vibrating motion. When cases are clean, the user simply pulls the drain plug and the media drains from the exit port into the media drain pan (included).

 **WARNING:** Cancer and Reproductive Harm  
[www.p65warnings.ca.gov](http://www.p65warnings.ca.gov)



**Best Selection  
Best Value!**



**Two  
Tumblers  
In One!**

**F. PRO 1200 Turbo® Tumbler** ⚠️  
*Our best seller and a true value for reloaders.*

The 1200 Pro features the same capacity as our original 1200 model at a very affordable price. The "built-in" sifter lid for quick and easy media separation saves you the cost of a separate media sifter. This economic 1200 Pro will hold 2 lbs. of media and will clean up to 350 cases per cycle.

- Turbo 1200 Pro Tumbler 115V ..... (#7631318)
- Turbo 1200 Pro Tumbler 230V ..... (#7631319)

**G. Turbo® Twin Tumbler** ⚠️  
*Real versatility and value*

Lyman's Turbo® Twin has become one of the most popular tumbler choices. It features our Lyman 1200 Pro Tumbler with an extra 600 bowl system so reloaders can interchange bowls for small or large capacity loads. 600 Bowl is also ideal for rock polishing or small polishing or deburring operations. This model also features Lyman advanced drive system for faster, more consistent tumbling action.

- Turbo Twin Tumbler 115V ..... (#7631327)
- Turbo Twin Tumbler 230V ..... (#7631328)

**H. Turbo® Accessory™ Bowls** ⚠️

Allows for tumbler upgrade. 600 bowl for liquid use with 1200 tumbler. 1200 bowl doubles capacity of 600. Hardware included.

- 600 Accessory Bowl (1 1/4 lbs.)..... (#7631399)
- 1200 Accessory Bowl (1 1/2 lbs.)..... (#7631323)



Lyman Turbo® Tumblers - Specifications and Capacities*					
	Media Charge (lbs.)	#.38 Spec. Cases	Bowl Capacity*	Bowl Size (Dia.)	Part No.
2500 Pro Mag Auto Flo	6.5	1000	1.75 Gal.	13"	7631697
2500 Pro Magnum	6	1000	1.75 Gal.	13"	7631692
2200 Auto-Flo ☼	5	750	1.5 Gal.	12"	7631601
1200 Auto-Flo ☼	3	350	1 Gal.	10"	7631630
1200 Pro ☼	2	350	1 Gal.	10"	7631318
Twin Tumbler	Use 600 & 1200 specifications				7631327
600	1	175	3 pints	8"	7631306

⚠️ **WARNING:** Cancer and Reproductive Harm  
www.p65warnings.ca.gov

**For pricing visit our website  
www.lymanproducts.com**



Small

Medium

Large

Jumbo



**Lyman Turbo® Case Cleaning Media**

Lyman Case Cleaning Media is the most effective choice for cleaning dirty and tarnished cases. A few hours in a Lyman Turbo® Tumbler and cases are clean, polished and ready for reloading. Note: weights are approximate, as containers are filled by volume, not weight.

**Tufnut™ Untreated**

Made from natural processed walnut shells. An effective choice for cleaning dirty and tarnished cases.

- 7631331 Small Tufnut Untreated 3lbs
- 7631395 Medium Tufnut Untreated 5.5lbs
- 7631337 Large Tufnut Untreated 12lbs
- 7631338 Jumbo Tub Tufnut Untreated 18lbs

**Natural Corncob**

Made from natural processed corncobs. An effective choice for cleaning dirty and tarnished cases.

- 7631389 Small Natural Corncob 2lbs
- 7631392 Medium Natural Corncob 3.5lbs
- 7631393 Large Natural Corncob 10lbs
- 7631336 Jumbo Tub Natural Corncob 16lbs

**Tufnut™ Plus**

Made from natural processed walnut shells, combined with a vibrant polishing agent for polishing cases to a high luster.

- 7631332 Small Tufnut Plus 3lbs
- 7631396 Medium Tufnut Plus 5.5lbs
- 7631333 Large Tufnut Plus 12lbs
- 7631334 Jumbo Tub Tufnut Plus 18lbs

**Corncob Plus**

Made from natural processed corncob, combined with a vibrant polishing agent for polishing cases to a high luster.

- 7631307 Small Corncob Plus 2lbs
- 7631394 Medium Corncob Plus 4.5lbs
- 7631320 Large Corncob Plus 10lbs
- 7631335 Jumbo Tub Corncob Plus 16lbs

**Flash Hole Cleaner**

Designed to remove bits of media from flash holes and primer pockets.

Flash Hole Cleaner ..... (#7777750)

**Brass Baggies**

Allows you to keep different batches of cases separate during the cleaning process. Use inside Tumbler while cleaning.

Brass Baggies (12 pack) ..... (#7631391)

**Turbo® Super Sifter**

The new Turbo Super Sifter allows cases to be easily separated from media while positioned over 7, 5, 3 or 2 gallon pails. These commonly available pails make the perfect container for storing used media. The sifter is equipped with large handles to make it easy to use with large volumes of cases and media. The extra deep design prevents media from spilling over the edges when pouring case and media from a tumbler and when in use.

- Works with commonly available 7, 5, 3 and 2 gallon pails
  - Extra deep design keeps media inside the sifter and off the floor
  - Large handles make the sifter easy to use
- Turbo Sifter ..... (#7631316)

**Turbo® Liquid Case Cleaner**

Turbo® Case Cleaner is an excellent liquid pre-cleaner for extremely fouled cases. Also may be used as a wet media. Use manually or with a tumbler.

Case Cleaner (16 fl. oz.) ..... (#7631340)

**Turbo® Brite Brass Polish**

Turbo® Brite Brass Polish is ideal for use as an additive when using untreated Corncob or Nutshell. Works with treated media to bring brass to a high luster.

Brass Polish (5 oz. bottle) ..... (#7631358)  
 Brass Polish (20 oz. bottle) ..... (#7631361)

**Turbo® Charger Media Reactivator** ⚠️

Turbo® Charger Media Reactivator will restore previously used corncob media. Simply add as instructed directly to media.

Media Reactivator (4 oz. bottle) ..... (#7631322)  
 Media Reactivator (16 oz. bottle) ..... (#7631324)

**⚠️ WARNING:** This product can expose you to chemicals including Chromium oxide, which is are known to the State of California to cause cancer and/or birth defects or other reproductive harm. For more information go to [www.p65warnings.ca.gov](http://www.p65warnings.ca.gov)

**Orange Turbo® Concentrated Case Cleaning Solution**

A powerful concentrated solution for cleaning or pre-cleaning large batches of cases. Simply mix with water and soak cases for 5 minutes or less. 16oz. bottle provides enough concentrate for 1 gallon of cleaning solution. Best of all, Orange Turbo actually smells like oranges!

Orange Turbo Concentrate 16 oz ..... (#7631355)

**⚠️ WARNING:** This product can expose you to chemicals including Hexavalent Chrome, which is are known to the State of California to cause cancer and/or birth defects or other reproductive harm. For more information go to [www.p65warnings.ca.gov](http://www.p65warnings.ca.gov)

**For pricing visit our website  
[www.lymanproducts.com](http://www.lymanproducts.com)**



**Turbo® Case/Media Separator**

Lyman puts a new “spin” on the media separator. Lyman engineers took a look at the media separators on the market and decided that they could do better. The result is a separator that incorporates many new features that makes the messy job of sifting media from cases much easier. The inner basket can be positioned to prevent it from moving as cases are poured in. The crank handle cover spins freely on the crank, making it much more comfortable to use. Improved latches provide a solid lock-up for the basket and the outer cover. The covers have interlocking edges to seal media and dust inside.

- Free spinning crank handle cover
  - Improved latches for a tight lock-up of the basket and cover
  - Can be used with either right or left hand
  - Tight seal to trap media and dust inside
- Media Separator ..... (#7631326)

**A. Super Moly Bore Cream**

This Superfine Moly bore cream is applied directly to the bore. Brushed into the pores of the rifling, it smooths and polishes the surface to a black, shiny friction-reducing finish. This reduces bore fouling and increases barrel life and accuracy.

Moly Bore Cream (#7631419) (3oz.)

**B. & C. Super Moly Spray**

Super Moly Spray coats bullets quickly and easily without the use of a tumbler. Simply spray on bullets and allow to dry for a few minutes. This thin spray coating can be used for Moly coating the bore and rifling of your firearm for total lubrication. It is also superb as a bullet mould release agent and rust preventative.

Moly Spray B. (#7631417) (4oz.)

Moly Spray C. (#7631415) (13oz.)

**⚠ WARNING:** This product can expose you to chemicals including Ethyl Benzene, which is are known to the State of California to cause cancer and/or birth defects or other reproductive harm. For more information go to [www.p65warnings.ca.gov](http://www.p65warnings.ca.gov)

**D. Super Moly “Superfine” Grade Moly Powder**

This Superfine Grade Molybdenum Disulfide coats the bullets quickly with a bright, shiny finish that will not rub off on your hands. Coating instructions included. Moly Powder (#7631412) (6oz.)

**Super Moly Finishing Accessory Set**

The kit contains two heavy duty long lasting bowls, (which will fit the Lyman 600 and 1200 tumblers and most other brand tumblers,) six ounces (6oz) of Superfine Grade Moly, Moly plating media, and fine finishing media. This kit will coat many thousands of bullets. Coating instructions are included. Accessory Set (#7631384)

**⚠ WARNING:** This product can expose you to chemicals including Crystalline Silica, which is are known to the State of California to cause cancer and/or birth defects or other reproductive harm. For more information go to [www.p65warnings.ca.gov](http://www.p65warnings.ca.gov)

**Finishing Kit Replacement Medias**

- (#7631381) Replacement Ceramic Media
- (#7631392) Untreated Cob Media 6 lb Easy Pour
- (#7631389) Untreated Cob Media 2 lb

**For pricing visit our website**  
[www.lymanproducts.com](http://www.lymanproducts.com)



**Lyman Trimmers  
Include 9  
Most Popular  
Trimmer Pilots**

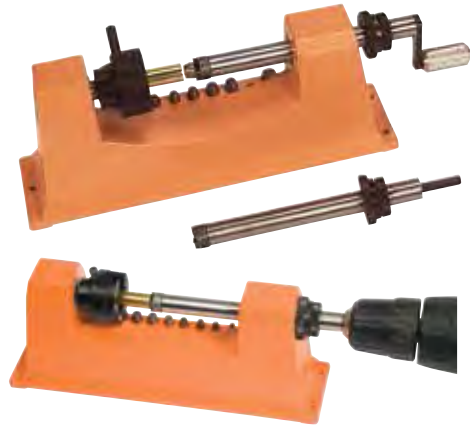

**Transform Your  
Trimmer into a  
Power Model**

**Power Adapter  
Installs  
in Seconds!**



**Carbide Cutter  
is ideal  
for high volume  
reloaders**



**SPECIAL  
50 BMG  
PRODUCT**

**Universal Trimmer®**

Lyman's Universal Trimmer features the popular Universal Chuckhead which handles any case from .17 caliber to .458. No costly collets required! Features coarse and fine adjustments. Adjusting ring lets you "dial in to an approximate setting for quick repeatability". Includes 9 of the most popular pilots. Optional power adapter lets you upgrade to power in seconds.  
Universal Trimmer ..... (#7862000)

**Universal Trimmer® Power Adapter**

Quickly convert to power trimming. Replace the existing trimmer shaft with the power adapter shaft and attach your drill. You're ready to power trim over 250 cases an hour. The adapter shaft comes with its own cutter and stop collars so you can convert back and forth from power to hand operation. The power adapter only fits the Lyman Universal Trimmer.  
Power Adapter ..... (#7862001)

**Universal Trimmer® Power Pack Combo**

The Power Pack Combo combines Lyman's Power Adapter with Lyman's popular Universal Trimmer. This allows quick and simple conversion from hand to power trimming. All you need is a standard electric hand drill or power screwdriver. Simply unscrew the cutter head from the standard shaft and slide it out of the trimmer. Then slip the power adapter shaft in its place, screw on the cutter head and attach your drill. You're ready to power trim over 250 cases an hour. The adapter shaft comes with its own cutter and stop collars and includes 9 pilot multi-pack  
Power Pack Combo ..... **Best Buy!** (#7862003)

**AccuTrimmer™**

Trims cases .17 through .458 Win. Mag. Uses standard shellholders to position cartridge and standard Lyman cutter heads and pilots. Includes our popular nine Pilot Multi-Pack. Purchase with shellholder set shown on page 17 and reloader has universal "trimability".  
AccuTrimmer Multi-Pack ..... (#786210)

**50 BMG AccuTrimmer™**

An AccuTrimmer designed specifically for 50 BMG cartridges. The shell head fits into a special holder which centers the case with the cutting shaft. A special 50 BMG pilot is included for perfect alignment and easy trimming.  
50 BMG ..... (#7862130)

**Universal® Carbide Case Trimmer**

This case trimmer adds the longer life and ultra-sharp cutting qualities of a carbide tool to Lyman's well-known Universal Trimmer. The Universal Carbide Case Trimmer takes advantage of the premium Carbide Cutter Head's fine grain and ultra-sharp cutting edge. This Carbide Head will hold its edge and dimensions longer, making this trimmer ideal for volume reloaders. Lyman's Universal Chuckhead handles any case from .17 caliber to .458 caliber with no collets or shell holders required and includes 9 of the most popular caliber pilots.  
Universal Carbide Case Trimmer ..... (#7862009)

**Accessory Carbide Cutter Head**

An optional carbide cutter fits all Lyman trimmers. Ideal for volume reloader.  
Cutter Head (2 oz.) ..... (#7822204)

**Ream/Clean Accessory Set**

A set of threaded accessories for Lyman trimmers or utility crank. Includes L & S primer pocket reamers and cleaners plus adapters.  
Access. Set (3 oz.) ..... (#777795)



**Case Trimmer Accessories**

**Replacement Cutter Head**  
Replacement (Steel) 2 pk. (4 oz.) ..... (#7822203)

**Nine Pilot Multi-Pack**  
Includes nine of the most popular pilots: 22, 24, 27, 28/7mm, 30, 9mm, 35 (38/357), 44 and 45A.  
Multi-Pack (2 oz.) ..... (#7822202)

**Extra Pilot**  
Pilot (1 oz.) ..... (State caliber, see list on Pg. 17)



Choose a Pilot set for Rifle or Pistol Calibers, or purchase the Universal System and buy pilots individually.

**E-ZEE Trim™ Hand Case Trimmer**

The industry leader in trimming and case prep innovation, Lyman introduces a new case trimming system for the reloader interested in economy or preferring to have an individual precision hand system for each caliber. The E-ZEE TRIM case trimming system allows the user to trim cases by hand or with a power attachment (included) to precise pre-set length - no adjustment of measuring needed. The trimmer comes with a case locking device, cutter, trim-to length pilot, cutter head and both hand and power trimming adapters. The trimmer works with any standard shell holder including Lyman, Redding, RCBS, Hornady and Lee Precision. Assembles in seconds and you are ready to trim cases. The E-ZEE TRIM system comes in three practical variations to make it simple for the consumer and simpler for the trade to stock.

**E-ZEE TRIM Rifle Set**

Includes hand trimmer, power adapter, cutter head and 5 most popular rifle caliber pilots (.223, .243, .270, .30-06, .308)

"E-ZEE" Trim Rifle Set (5 Pilots\*) ..... (#7821891)

**E-ZEE TRIM Handgun Set**

Includes hand trimmer, power adapter, cutter head, and 6 most popular handgun caliber pilots (9mm, 38 Spec, 357, 40 S&W, 44 Mag, 45 ACP)

"E-ZEE" Trim Handgun Set (6 Pilots\*\*) ..... (#7821892)

**E-ZEE TRIM Universal Set**

Includes hand trimmer, power adapter, and cutter head. Just add the pilot for the caliber you wish to trim.

"E-ZEE" Trim Universal (No Pilots) ..... (#7821890)

**E-ZEE Trim™ Rubber Handle Accessory**

Slips easily over the adapter handle to provide a cushioned, comfortable grip.

E-ZEE Trim Handle ..... (#7821893)



**E-ZEE TRIM PILOTS**

- "E-ZEE" Trim Pilot - .204 Ruger ..... (#7821900)
- "E-ZEE" Trim Pilot - .223\* ..... (#7821901)
- "E-ZEE" Trim Pilot - .22-250 ..... (#7821902)
- "E-ZEE" Trim Pilot - 22 Nosler ..... (#7821937)
- "E-ZEE" Trim Pilot - 224 Valkyrie . . . NEW FOR 2019 . . . . (#7821940)**
- "E-ZEE" Trim Pilot - 243\* ..... (#7821903)
- "E-ZEE" Trim Pilot - 6mm Creedmoor ..... (#7821936)
- "E-ZEE" Trim Pilot - 25-06 ..... (#7821911)
- "E-ZEE" Trim Pilot - 6.5 Grendel ..... (#7821939)
- "E-ZEE" Trim Pilot - 6.5 x 55 ..... (#7821912)
- "E-ZEE" Trim Pilot - .270 Win.\* ..... (#7821904)
- "E-ZEE" Trim Pilot - 7 x 57 ..... (#7821913)
- "E-ZEE" Trim Pilot - 7mm Rem ..... (#7821905)
- "E-ZEE" Trim Pilot - 30-30 ..... (#7821906)
- "E-ZEE" Trim Pilot - 300 AAC Black-Out ..... (#7821914)
- "E-ZEE" Trim Pilot - .308 Win.\* ..... (#7821907)
- "E-ZEE" Trim Pilot - .30-06\* ..... (#7821908)
- "E-ZEE" Trim Pilot - .300 Win. Mag. .... (#7821909)
- "E-ZEE" Trim Pilot - 300 WSM ..... (#7821915)
- "E-ZEE" Trim Pilot - 7.62 x 39 ..... (#7821916)
- "E-ZEE" Trim Pilot - 303 British ..... (#7821917)
- "E-ZEE" Trim Pilot - 8 x 57 ..... (#7821918)
- "E-ZEE" Trim Pilot - 338 Win Mag ..... (#7821919)
- "E-ZEE" Trim Pilot - 458 SOCOM ..... (#7821938)
- "E-ZEE" Trim Pilot - .45-70 ..... (#7821910)
- "E-ZEE" Trim Pilot - 380 Auto ..... (#7821931)
- "E-ZEE" Trim Pilot - 9mm\*\* ..... (#7821928)
- "E-ZEE" Trim Pilot - .38 Spec\*\* ..... (#7821925)
- "E-ZEE" Trim Pilot - .357\*\* ..... (#7821926)
- "E-ZEE" Trim Pilot - .40 S&W\*\* ..... (#7821929)
- "E-ZEE" Trim Pilot - .44 Mag\*\* ..... (#7821927)
- "E-ZEE" Trim Pilot - .45 ACP\*\* ..... (#7821930)
- "E-ZEE" Trim Pilot - 45 Colt ..... (#7821932)
- "E-ZEE" Trim Pilot - 6.5 Creedmoor ..... (#7821922)
- "E-ZEE" Trim Pilot - 7mm-08 ..... (#7821921)
- "E-ZEE" Trim Pilot - 30 Carbine ..... (#7821920)
- "E-ZEE" Trim Pilot - 338 Lapua ..... (#7821935)
- "E-ZEE" Trim Pilot - 357 Sig ..... (#7821933)
- "E-ZEE" Trim Pilot - 10mm Auto ..... (#7821934)

\* Pilots included in Rifle Set. \*\* Pilots included in Pistol Set.

For pricing visit our website  
www.lymanproducts.com

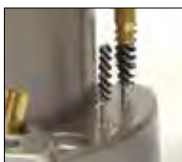

• Case Neck Lube Brushes



• Primer Pocket Uniformer



• Outside Deburr Tool



• Primer Pocket Cleaner



• VLD Inside Deburr



• Primer Pocket Reamer



*New improved drivetrain for quieter, smoother operation with greater torque. Smaller "footprint" takes up less bench space and a repositioned On/Off switch for easier access.*

**Case Prep Xpress™**

Lyman, the industry innovator in case preparation for decades, provides the most complete electric case prep system ever developed. The Case Prep Express is the only "All-Inclusive" System offering all the most popular case prep accessories driven by a high torque gear motor. The Case Prep Xpress allows the user to simultaneously do 5 different case prep operations. Removable dump pan provides easy clean up of brass shavings. The best part is that all accessories are included from the start, no need to have to separately purchase expensive additional accessories. Included

**Accessories:**

- Inside Deburr (VLD) Tool
- Outside Deburr Tool
- Primer Pocket Uniformers (Small & Large)
- Primer Pocket Reamers (Small & Large)
- Primer Pocket Cleaners (Small & Large)
- Case Neck Brushes (25 Cal, 30 Cal, 38 Cal, 45 Cal)
- Case Neck Lube (Mica)
- Removable Brass Shavings Dump Pan
- Clean-up brush

Case Prep Xpress (115V) ..... (#7810220)  
 Case Prep Xpress (230V) ..... (#7810223)

**Ultimate Case Prep Kit**

The Ultimate Case Prep Kit gives the reloader all of their necessary case prep tools in one handy organized storage case. The kit offers a great value compared to purchasing each item individually – a 40% savings! Everything is there to process cases after trimming as well as accuracy prep work for the most accurate reloads possible.

**Kit Contains:**

- E-ZEE Case Gauge™
- Magnum Inertia Bullet Puller with two collets (5.7 x 28FN - Largest Magnums)
- Extra Large Deburr Tool (Inside & Outside)
- Outside Chamfer Tool
- Flash Hole Uniformer
- VLD Chamfer Tool
- Small Primer Pocket Reamer
- Large Primer Pocket Reamer
- Small Primer Pocket Uniformer
- Large Primer Pocket Uniformer
- Small Primer Pocket Cleaner
- Large Primer Pocket Cleaner
- Nylon Case Neck Brushes: 25 Cal, 30 Cal, 38 Cal, 45 Cal plus handle for brushes
- Dry Case Neck Lube

Ultimate Case Prep Kit ..... (#7810209)



**20mm Vulcan Case Prep Tool/Novelty Round**

Lyman has machined the most unusual case prep tool available! Cut to the same dimensions as the 20mm round used in the famous Vulcan Rotary Cannon, the cartridge has a 8-32 thread in the base to accept case prep tools. It comes packed with large and small primer pocket reamers and cleaners. In addition, the round is hollow and can store the tools inside by unthreading the bullet from the case. When not in use, the round makes a great display piece and conversation starter! CNC machined from solid aluminum and anodized to resemble the real thing!

- Dimensioned the same as 20mm Vulcan ammo
- Doubles as a case prep tool
- Includes large and small primer pocket reamers and cleaners
- Bullet unthreads from the case to store case prep tools inside
- CNC machined from solid aluminum

20mm Vulcan Case Prep Tool ..... (#7777820)





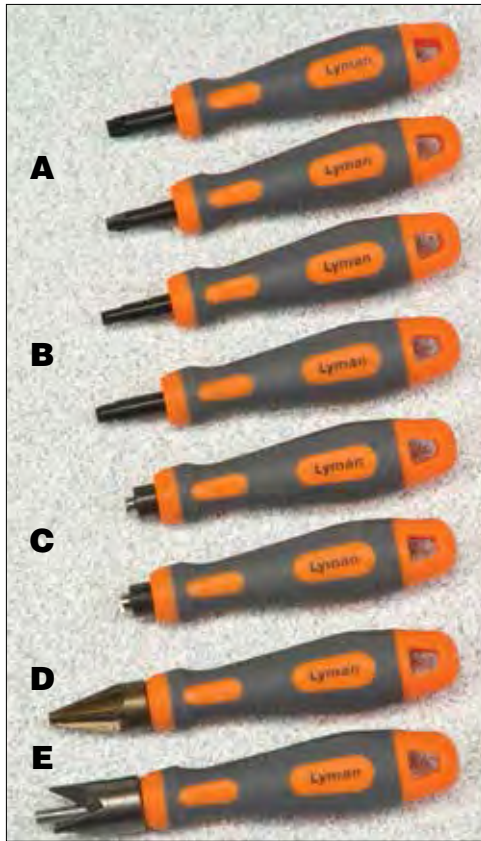

**A. Primer Pocket Reamers**

Remove military crimps and rough metal edges from a primer pocket. Available in large and small sizes.  
 Reamer Large (#777785) ..... \$11.75  
 Reamer Small (#777784) ..... \$11.75

**B. Primer Pocket Cleaners**

Clean out fouling of primer pocket bottoms. Available in large and small sizes.  
 Cleaner Large ..... (#777790)  
 Cleaner Small ..... (#777791)



**C. Primer Pocket Uniformers**

This precision tool allows reloaders to assure uniform primer depth which produces consistent ignition and improves accuracy. Uniforming tool has a pre-set stop collar set to SAAMI specs. Reloader simply inserts and turns. Available in large and small sizes. (Large for rifle cases only, Small for rifle or pistol cases)  
 Uniformer Large ..... (#7810215)  
 Uniformer Small ..... (#7810218)

**Large Pistol Primer Pocket Uniformer**

The Large Pistol Primer Pocket Uniformer is designed to cut primer pockets to a uniform depth that can produce more consistent ignition and lead to greater accuracy. The Primer Pocket Uniformer cuts to a uniform depth and at the same time squares the seating surface for the anvil of the primer.  
 Large Pistol Uniformer ..... (#7810219)

**Universal Case Prep Accessory Set**

This handy kit is the perfect accessory to your Universal Case Trimmer. It contains everything you need to properly complete case preparation, all in a durable storage case. Save over 30% versus individual purchases.

- Set includes:
- Large & Small Primer Pocket Cleaners
  - Large & Small Primer Pocket Reamers
  - Large & Small Primer Pocket Uniformers
  - Outside Deburring Tool
  - Inside Deburring Tool VLD
- Case Prep Accessory Set ..... (#7810212)

**D. Lyman VLD (Very Low Drag) Chamfer/ Reamer**

Lyman's VLD Chamfer/ Reamer eliminates damage to bullets caused by the sharp edges of the cartridge case neck. The long boat tail on VLD bullets are cut by the case mouth when chamfered with a standard 45 degree reamer. The sharp 22 degrees on the VLD reamer allows all bullets to slip easily into the case ensuring the best accuracy. Recommended for Sierra VLD and other manufacturer's VLD bullets.  
 Chamfer/Reamer ..... (#777789)

**E. Outside Chamfer Tool**

Bevels and removes burrs from the outside of the case mouth. Precision machined and hardened, fits all cases from .17 to .45 caliber.  
 Outside Deburring Tool ..... (#7810222)

**Carbide VLD (Very Low Drag) Chamfer/ Reamer**

For many years, the Lyman VLD Chamfer Tool has been extremely popular with reloaders due to its gentle 22 degree cutting angle. It cuts much easier than standard 45 degree angle reamers and works great for any long boat tail (very low drag) bullet designs. Now this popular tool is available in long lasting, super sharp carbide. The precision ground carbide tool will last a lifetime without showing any signs of wear, perfect for the high volume loader. The Carbide VLD Chamfer/Reamer will be available on our comfortable handle for hand held use or by itself for use in our Case Prep Express or other brands of case prep machines..

- Carbide VLD Chamfer Reamer with handle ..... (#777792)  
 Carbide VLD Chamfer Reamer tool head only ..... (#777794)

**Ream/Clean Accessory Set**

A set of threaded accessories for Lyman trimmers or utility crank. Includes L&S primer pocket reamers and cleaners plus adapters.  
 Accessory Set (3 oz.) ..... (#777795)



For pricing visit our website  
[www.lymanproducts.com](http://www.lymanproducts.com)



**A. Quick Slick™ Pump Case Lube**   
 Lyman's popular "Quick Slick" spray case lube is now available in a large and economical 16oz pump spray. The large ergonomic spray bottle allows you to spray an entire loading block of cases in seconds. Dries quickly to a light, clear film, and eliminates messy lube pads.  
 Quick Slick Pump Spray Lube 16oz. .... (#7631298)

**B. Lyman Loading Block**  
 Essential accessory for organization and speed, twin loading block holds 50 rifle or pistol cases .22 through .45 caliber. Molded of heavy duty plastic.  
 Loading Block (7 oz.) ..... (#7728054)

**C. Case Neck Dipper**  
 Prolongs case life and makes resizing easier by cleaning and lubricating the interior of bottleneck cases. After cleaning with brushes, dip the case mouths into dry lube to reduce friction from sizing die expander button. Includes 3 brushes and dry lube for cleaning all cases from .17 to .45 caliber.  
 Case Neck Dipper complete (2 oz.) ..... (#7631360)  
 Replacement. Lube Refill (3.4a) ..... (#7991415)

**D. Quick Slick™ Case Lube**   
 This petroleum based lube in a can allows you to spray an entire loading block of cases in seconds. Super slick lube helps prevent case dents.  
 Spray Lube 5.5oz. .... (#7631296)

**E. Extra-Large Caliber Deburring Tool**  
*(extra large calibers up to .60)*  
 This tool was designed for inside and outside deburring of cartridge cases from .17 caliber to 60 caliber. Ideal for black powder cartridge shooters. A must for 50 BMG reloading. The 30 degree angle cutter bevels inside the mouth of the case, allowing the bullets to slide in without deforming.  
 Extra-Large ..... (#7810206)

**F. Deburring Tool**  
 Bevels and removes burrs from both inside and outside of case mouth. Precision machined and hardened, fits all cases from .17 to .45 caliber.  
 Deburring Tool (2 oz.) ..... (#7810199)

**G. Primer Tray**  
 Flips primers anvil-side-up for easier loading. Spread on specially grooved surface, replace lid and shake. Made of durable plastic for safety.  
 Primer Tray (2 oz.) ..... (#7728053)

 **WARNING:** This product can expose you to chemicals including Propylene Glycol T-Butyl Ether or Toluene, which are known to the State of California to cause cancer and/or birth defects or other reproductive harm. For more information go to [www.p65warnings.ca.gov](http://www.p65warnings.ca.gov)

**Case Lube Kit**  
 Everything needed to clean and lube cases, inside and out, in one package. Large cloth lubricating pad in plastic case dispenses lube evenly. Includes 2 oz. of Lyman Case Lube, 3 interchangeable neck brushes and a cushioned plastic handle.  
 Case Lube Kit Complete (1 lb.) ..... (#7631300)  
 Case Lube (2 oz.) ..... (#7631301)  
 Lube Pad Only (9 oz.) ..... (#7631302)



**Ultra-Fine Dry Case Neck Lube**  
 Many uses for this specialty lube. Dip case neck into lube before sizing to reduce friction from sizing die expander button. Also works great on keys that stick in locks.  
 Ultra-fine Lube (3.4a) ..... (#7991415)

**H. Lyman Case Care Kit**  
 The utility crank accepts most Lyman accessories and any tool with an 8-32 thread. Kit includes both Large & Small Primer Pocket Reamers, Cleaners, & Uniformers, as well as Inside and Outside Deburring Tools.  
 Case Care Kit (1 lb.) ..... (#7777793)

**I. Lyman Magnum Inertia Bullet Puller**  
 Safely strips loaded rounds in seconds without damage to bullet or case. Features newly engineered head design that allows use on full range of calibers from tiny 5.7 X 28FN to the largest Magnums. New "full size" ergonomic molded handle with rubber insert for comfort and sure grip.  
 Bullet Puller ..... (#7810216)

**J. Flash Hole Cleaner**  
 Designed to remove bits of media from flash holes and primer pockets.  
 Flash Hole Cleaner ..... (#7777750)

**K. Flash Hole Uniformer**  
 This handy tool removes internal flash hole burrs. Features a tool steel cutter which is inserted into the flash hole through the case neck. Adjustable stop collar allows use with any size case. Burrs are removed with a clockwise turn. Fits .22 to .45 Calibers.  
 Flash Hole Uniformer (4 oz.) ..... (#7777760)



**A. E-ZEE Case Gauge™**

This full-size version measures the case length of over 70 popular rifle and pistol cases. Many new cartridges are included like the Winchester Short Mags, 204 Ruger, 500 S&W and others. Precisely made, this rugged metal gauge makes sorting cases quick, easy and accurate.

E-ZEE Case Gauge ..... (#7832215)

**B. Pistol E-ZEE Case Gauge™**

Here's Lyman's popular E-ZEE Case Gauge in a smaller, more convenient size yet covering virtually any pistol case. The precise metal "no-go" gauge makes judging case length fast, easy and accurate.

E-ZEE Case Gauge ..... (#7832217)

**NEW E-ZEE™ Case Gauges**

Lyman's E-ZEE Case Gauges have proven to be a real time saver for reloaders, and are available for most common calibers. The precisely machined metal "No-Go" gauge is cut to SAAMI maximum allowable case length. If a case fails to pass through the gauge, it needs to be trimmed. For 2019, Lyman is now offering two specialized E-ZEE Case Gauges designed for Cowboy Action shooters and those reloading for the wide range of MSR calibers. These convenient gauges are offered for the following calibers:

**C. Cowboy Action:** 32 H&R Mag, 32-20, 38 Long Colt, 38 Special, 38-40/44-40, 44 Russian, 44 Colt/45 Schofield, 44 Spec, 45 Colt  
E-ZEE Case Gauge - Cowboy ..... (#7832227)

**D. MSR:** 223/5.56, 224 Valkyrie, 6.5 Grendel, 6.5 Creedmoor, 6.8 SPC, 300 Blackout, 308 Win/7.62, 7.62x39, 9mm, 450 Bushmaster, 458SOCOM, 50 Beowulf plus 2.260" max. cartridge OAL  
E-ZEE Case Gauge - MSR ..... (#7832225)

**E. Case Preparation Kit**

Perfect accessory to your tumbler or case trimmer. It contains everything you need to properly complete case preparation: large and small primer pocket reamer for military brass, large and small primer pocket cleaner, 2 cushioned plastic handles, 3 case neck brushes and a case deburring tool. All in a handy storage pouch and box. Save 25% versus individual purchases.

Case Preparation Kit (11 oz.) ..... (#777796)



**F. Case Prep Multi-Tool™**

Lyman's Unique New Case Prep Multi-Tool provides the reloader with all the essential Case Prep Accessories in one compact, Double-ended Storage Tool. Unique knurled handle un-threads in the middle to store all parts. Both ends of the handle are threaded to allow two tool heads to be mounted simultaneously. Includes:

- Outside Deburring Tool
  - VLD Inside Deburring Tool
  - Large & Small Primer Pocket Cleaners
  - Large & Small Primer Pocket Reamers
- Case Prep Multi-Tool ..... (#7777800)

**G. 50 BMG Case Prep Multi-Tool™**

Reloaders of the Big 50 no longer have to make do with undersized standard or makeshift tools to prep their 50 BMG cases. Lyman has engineered full-sized .50 caliber tools and put them together in a handy double ended storage handle - always ready and all in one place. The unique knurled handle un-threads in the middle to store all the parts. Both ends of the handle are threaded to allow a tool head to be mounted on each end. In addition to the double ended, storage handle the set includes:

- .50 Cal. Outside Deburring Tool
  - .50 Cal. VLD Inside Deburring Tool
  - .50 BMG Primer Pocket Reamer, Cleaner, Uniformer
- Case Prep Multi-Tool ..... (#7777811)

**WARNING:** Cancer and Reproductive Harm  
www.p65warnings.ca.gov

For pricing visit our website  
[www.lymanproducts.com](http://www.lymanproducts.com)



**Lyman Bleacher Blocks® For Handgun Calibers**

Once reloaders began using our popular Bleacher Blocks for rifle cases, we quickly had requests for handgun size Bleacher Blocks. Our new Bleacher Blocks answer this request. The handgun blocks follow the same proven stepped design of the rifle blocks, however with shallower holes suitable for handgun cases. Just like the rifle blocks, the stepped design allows you to easily grip a single case without jamming your fingers down into a group of cases like in traditional loading blocks. The stepped design also produces a smaller footprint so they take up less valuable bench space. Made of tough, durable polymer, the handgun size Bleacher Blocks come in two sizes to fit most popular handgun calibers and hold 50 cases.

- Molded to closely fit specific case sizes, .445", & .565"
- Made of tough, durable polymer
- Unique stepped design makes it easy to add or remove cases, even when full
- Takes up less bench space than traditional blocks

• **.445" hole size fits:** 380 Auto, 9mm Luger, 38 Super, 357 Sig, 38 Special, 357 Mag, 40 S&W, 10mmAuto

• **.565" hole size fits:** 44 Mag, 45 ACP, 45 GAP, 45 Colt, 454 Casull, 460 S&W, 500 S&W

.445 Handgun Bleacher Blocks ..... (#7728088)  
 .565 Handgun Bleacher Blocks ..... (#7728089)



**Lyman Bleacher Blocks® for Rifle Calibers**

Lyman has taken a "step up" in loading block design with our new Bleacher Blocks. Just as bleachers allow people to see over those in front of them, our new loading blocks allow for easier handling of cases in and out of the loading block. Our stepped design allows you to easily grip a single case without jamming your fingers down into a group of cases like in traditional loading blocks, and allows for a smaller "footprint" on your bench. Made of tough, durable polymer, the Bleacher Blocks are molded in three sizes to closely fit a variety of rifle cases. One size fits 223 size case heads, another fits 308 size case heads and the third fits belted magnum size cases. All hold 50 rounds.

- Molded to closely fit specific case sizes, .388", .485", & .565"
- Made of tough, durable polymer
- Unique stepped design makes it easy to add or remove cases, even when full
- Takes up less bench space than traditional blocks

• **.388" hole size – fits:** 17 Rem., 17 Rem. Fireball, 204 Ruger, 222 Rem., 222 Rem. Mag., 223 Rem., 300 AAC

• **.485" hole size – fits:** 225 Win., 22-250, 220 Swift, 243 Win., 6mm Rem., 240 Wea. Mag, 250 Sav., 257 Roberts, 25-06, 260 Rem., 6.5x55, 270 Win., 7mm-08, 7mm Mauser, 280 Rem., 300 Sav., 308 Win., 30-06, 7.65 Arg. Mauser, 8mm Mauser, 338 Fed., 358 Win, 35 Whelen

• **.565" hole size – fits:** 223 WSSM, 243 WSSM, 25 WSSM, 257 Wea. Mag, 264 Win Mag, 270 WSM, 270 Wea. Mag, 7mm Rem. Mag, 7mm Wea. Mag, 7mm WSM, 7mm Rem. SAUM, 7mm STW, 7mm Rem. Ultra Mag, 300 H&H Mag, 300 Rem. SAUM, 300 WSM, 300 Win. Mag, 300 Rem. Ultra Mag, 300 Wea. Mag, 8mm Rem. Mag, 325 WSM, 338 Win. Mag, 340 Wea. Mag, 338 Rem. Ultra Mag, 375 H&H Mag, 375 Ruger, 375 Rem. Ultra Mag, 416 Rem. Mag, 450 Marlin, 458 Win. Mag

.388 Bleacher Block ..... (#7728085)  
 .485 Bleacher Block ..... (#7728086)  
 .565 Bleacher Block ..... (#7728087)

**For pricing visit our website  
[www.lymanproducts.com](http://www.lymanproducts.com)**



**Custom Fit Loading Blocks**

Lyman's Custom Fit Loading Blocks are designed to provide a precise fit for a family of cartridge sizes. Made from tough, durable polymer, Custom Fit Loading Blocks hold 50 cartridges and will securely nest together for easy storage. Custom Fit Loading Blocks come in 6 sizes to match up with a large variety of cartridges. Each block is clearly marked with the diameter of the cartridge storage hole.

- Custom Fit Loading Block .388 ..... (#7728090)
- Custom Fit Loading Block .445 ..... (#7728091)
- Custom Fit Loading Block .485 ..... (#7728092)
- Custom Fit Loading Block .530 ..... (#7728093)
- Custom Fit Loading Block .565 ..... (#7728094)
- Custom Fit Loading Block .615 ..... (#7728095)

**Lyman Deluxe Anodized Aluminum Loading Blocks**

Lyman's Deluxe Anodized Aluminum Loading Blocks are made for precision reloaders who want their equipment to be as high quality as the ammunition that they produce. The blocks are CNC milled from a solid billet of 6061-T6 aluminum to tight tolerances for a close fit to specific cartridges, unlike the common one-size-fits-all plastic blocks. The blocks are made in three sizes to fit most common rifle head sizes, and will hold 50 rounds. Blocks come with stick-on rubber non-slip feet to keep them from sliding on your bench.

- **.388" hole size – fits:** 17 Rem., 17 Rem. Fireball, 204 Ruger, 222 Rem., 222 Rem. Mag., 223 Rem., 300 AAC
- **.485" hole size – fits:** 225 Win., 22-250, 220 Swift, 243 Win., 6mm Rem., 240 Wea. Mag, 250 Sav., 257 Roberts, 25-06, 260 Rem., 6.5x55, 270 Win., 7mm-08, 7mm Mauser, 280 Rem., 300 Sav., 308 Win., 30-06, 7.65 Arg. Mauser, 8mm Mauser, 338 Fed., 358 Win, 35 Whelen
- **.565" hole size – fits:** 223 WSSM, 243 WSSM, 25 WSSM, 257 Wea. Mag, 264 Win Mag, 270 WSM, 270 Wea. Mag, 7mm Rem. Mag, 7mm Wea. Mag, 7mm WSM, 7mm Rem. SAUM, 7mm STW, 7mm Rem. Ultra Mag, 300 H&H Mag, 300 Rem. SAUM, 300 WSM, 300 Win. Mag, 300 Rem. Ultra Mag, 300 Wea. Mag, 8mm Rem. Mag, 325 WSM, 338 Win. Mag, 340 Wea. Mag, 338 Rem. Ultra Mag, 375 H&H Mag, 375 Ruger, 375 Rem. Ultra Mag, 416 Rem. Mag, 450 Marlin, 458 Win. Mag

- .388 Aluminum Loading Block ..... (#7728080)
- .485 Aluminum Loading Block ..... (#7728081)
- .565 Aluminum Loading Block ..... (#7728082)

0.388 Fits:	17 Hornet 17 Rem 17 Rem Fireball 204 Ruger 22 Hornet 222 Rem 222 Rem Mag	223 Rem 30 Carbine 300 AAC 32 ACP 32 S&W L 32 H&R 327 Federal	0.530 Fits:	284 Win 7-30 Waters 30-30 Win 32 Win Spc. 32-40 38-55 375 Win 38-40	44-40 41 Rem Mag 44 Special 44 Rem Mag 444 Marlin 45 Colt 454 Casull 460 S&W
0.445 Fits:	218 Bee 224 Wea. Mag 25-20 6.5 Grendel 6.8mm Rem 32-20 380 Auto 9mm Luger	38 Super 357 Sig 38 S&W 38 Spec 357 Mag 9mm Makarov 40 S&W 10mm Auto	0.565 Fits:	223 WSSM 243 WSSM 25 WSSM 257 Wea. Mag 264 Win Mag 26 Nosler 270 WSM 270 Wea. Mag 7mm Rem Mag 7mm Wea. Mag 7mm WSM 7mm Rem SAUM 28 Nosler 7mm STW 7mm Rem Ultra Mag 30-40 Krag 300 H&H 300 Rem SAUM 300 RCM 300 WSM 300 Win Mag	300 Rem Ultra Mag 300 Wea. Mag 303 British 8mm Rem Mag 325 WSM 338 RCM 338 Win Mag 340 Wea. Mag 338 Rem Ultra Mag 350 Rem Mag 375 H&H 375 Ruger 375 Rem Ultra Mag 405 Win 416 Rem Mag 450 Marlin 458 Win Mag 480 Ruger 50 AE 500 S&W
0.485 Fits:	225 Win 22-250 220 Swift 243 Win 6mm Rem 240 Wea. Mag 250 Sav 257 Roberts 25-06 260 Rem 6.5x55 6.5 Creedmoor 6.5-284 270 Win 7mm-08 7mm Mauser	280 Rem 300 Sav 308 Win 30-06 7.62x39 7.65 Arg. Mau. 8mm Mauser 338 Federal 35 Rem 358 Win 35 Whelen 9.3x62 450 Bushmaster 45 ACP 45 GAP	0.615 Fits:	30-378 Wea. Mag 7.62x54R 338-378 Wea. Mag 338 Lapua 348 Win 378 Wea. Mag 40-65 416 Rigby	416 Wea. Mag 45-70 45-90 45-100 45-110 45-120 460 Wea. Mag



For pricing visit our website  
www.lymanproducts.com



**Rifle Case Length Headspace Gauges**

To achieve the highest degree of safety and accuracy, Lyman recommends that all bottleneck rifle cases be inspected after resizing to ensure that the proper headspace dimension is maintained. Simply insert the case into the gauge to insure that it does not exceed the maximum or fall below the minimum allowable headspace. In addition, the gauge will identify a case which exceeds the maximum allowable case length . Caution: Cases found with excessive headspace should be destroyed immediately.

.204 Ruger . . . . .	#7990342
.22-250 . . . . .	#7832324
.223 . . . . .	#7832323
6.5 Creedmoor . . . . .	#7990346
.243 Win. . . . .	#7832322
7mm-08 . . . . .	#7990343
.270 Win. . . . .	#7832325
.308 Win. . . . .	#7832321
300AAC Blackout . . . . .	#7832338
300 WSM . . . . .	#7990344
30-06 . . . . .	#7832320
.338 Lapua . . . . .	#7990345
7.62x39 . . . . .	#7990394
6mm Creedmoor . . . . .	#7832327
22 Nosler . . . . .	#7832328

**NEW FOR 2019**

10mm Auto Pistol Max . . . . .	#7832333
224 Valkyrie . . . . .	#7832339

**Pistol Maximum Cartridge Gauges**

These precision made gauges allow the reloader to check the case length, diameter and overall cartridge length of pistol ammunition. This inspection is considered mandatory by top competitive shooters who demand 100% reliability for their competition ammo.

.380 Auto . . . . .	#7832337
.9mm . . . . .	#7832330
.40 S&W . . . . .	#7832332
.45 ACP . . . . .	#7832331
44 Mag. . . . .	#7832336

**Reloading Accessories for 224 Valkyrie**

In Addition to the MSR Die Set listed on page 11, Lyman is also offering everything else you'll need to reload the 224 Valkyrie cartridge.

**Case Length/Headspace Gauge**

Simply insert the case into the gauge to ensure that it does not exceed the maximum or fall below the minimum allowable headspace. In addition, the gauge will identify a case which exceeds the maximum allowable case length.

**E-ZEE™ Trim Pilot**

Fits the Lyman E-ZEE Trim Hand Case Trimming System. 224 Valkyrie E-ZEE Trim Pilot . . . . . (#7821940)

**50 BMG Cartridge Length Headspace Gauge**

50 BMG . . . . . (#7832326)



**Stainless Steel Dial Caliper**

This precision tool will deliver unflinching .001" accuracy. Includes storage case. Stainless Steel Caliper (1 lb.) . . . . . (#7832212)



**Reloader's 1" Micrometer**

Traditional vernier micrometer offers precision at an affordable price. Reads to .0001" on a Vernier scale. Spindle lock and friction thimble. Padded wooden storage box included. 1" Micrometer . . . . . (#7832230)



**Electronic Stainless Steel Caliper**

Digital caliper features high tech stainless design with direct digital readout. Switch back & forth from inches to millimeters with the touch of a button. Accurate to .001"/0.1mm. Includes storage case. Electronic Caliper (1 lb.) . . . . . (#7832218)



**Ammo Checkers™**

Check the quality and consistency of both reloaded rounds and purchased ammo. A must for any auto shooter for easy and consistent feed. You can't afford mis-feeds, so get the easiest "go" gauge available today!

Lyman's Ammo Checkers are gauges that allow a reloader to quickly confirm that their ammunition will fit in their chamber. Machined from solid blocks of 6061 T6 aircraft grade aluminum and cut with custom tooling to SAAMI minimum chamber dimensions, Ammo Checkers are available in three designs covering most common handgun and rifle calibers. One gauge will work with a variety of calibers. (See photo.) Just drop your loaded rounds in the ammo checker, and if the round fits into the gauge, it will fit in the gun's chamber. Each caliber is clearly engraved on the gauge. Bright orange anodizing makes them easy to find on your reloading bench.

**Handgun gauge** works with 380 Auto, 9mm Luger, 38 Super, 40 S&W, 45 ACP, 38/357, 44 Mag/Spl, and 45 Colt

**Small Rifle gauge** works with 204 Ruger, 22 Hornet, 223 Rem, 22-250, 300 AAC Blackout and 7.62x39mm

**Large Rifle gauge** works with 243 Win, 270 Win, 30-30 Win, 308 Win, 30-06 and 300 WSM

- Handgun Ammo Checker . . . . . (#7833000)
- Small Rifle Ammo Checker . . . . . (#7833001)
- Large Rifle Ammo Checker . . . . . (#7833002)



**MSR Ammo Checker Block**

Lyman MSR Ammo Checkers are machined from solid blocks of 6061 T6 aircraft grade aluminum and cut with custom tooling to minimum chamber dimensions. Their black anodized finish matches your favorite "black" rifle. Check the quality and consistency of both loaded rounds and purchased ammo. A must for any AR shooter. You can't afford mis-feeds, so get the easiest "Go" gauge available for modern sporting rifle calibers.

- Covers 223/5.56, 6.5 Grendel, 6.8 Rem. SPC, 7.62x39, 300AAC Blackout, 450 Bushmaster, 458 SOCOM and 50 Beowulf
- CNC machined to minimum chamber specs
- Confirm ammo will chamber smoothly

MSR Ammo Checker Block . . . . . (#7833003)



**Multiple Blocks**

Lyman's multi-caliber Ammo Checkers have been extremely popular with reloaders. Now based on demand from our customers, Lyman is adding gauges having 8 chambers with all being of the same caliber. Blocks will be available in 9mm, 45 ACP and 223 Rem. These gauges allow reloaders to take multiple cartridges right off the press and check them as they go. If they fit, they will chamber in your gun.

**Single Caliber Model Ammo Checkers™**

Lyman's multi-caliber Ammo Checkers have proven to be extremely popular with reloaders since their introduction last year. Ammo Checkers are gauges that verify the quality and consistency of both reloaded and factory ammo. They are machined from solid aluminum and cut with custom tooling to SAAMI minimum chamber tolerances. Just drop your cartridge into the gauge and if it fits, it will chamber in your gun.

Lyman has expanded their line of Ammo Checkers into other calibers that are not included in the multi-caliber blocks. Each gauge is clearly marked for caliber and is anodized in a bright orange color so that they will be easy to spot on your reloading bench.

- Single Caliber 12ga . . . . . (#7833010)
- Single Caliber 20ga . . . . . (#7833011)
- Single Caliber 223 Remington. . . . . (#7833020)
- Single Caliber 22 Nosler. . . . . (#7833025)
- Single Caliber 6mm Creedmoor. . . . . (#7833021)
- Single Caliber 6.5 Creedmoor . . . . . (#7833012)
- Single Caliber 7mm Rem Mag . . . . . (#7833013)
- Single Caliber 7mm x 57 Mauser . . . . . (#7833014)
- Single Caliber 308 Win. . . . . (#7833024)
- Single Caliber 300 Win Mag . . . . . (#7833015)
- Single Caliber 7.62 x 54R . . . . . (#7833016)
- Single Caliber 8mm x 57 Mauser. . . . . (#7833017)
- Single Caliber 338 Lapua Mag . . . . . (#7833018)
- Single Caliber 45-70 Govt. . . . . (#7833019)



**NEW FOR 2019**

**Single Ammo Checkers**

- Single Caliber 224 Valkyrie . . . . . (#7833030)
- Single Caliber 6.8 Rem SPC. . . . . (#7833022)
- Single Caliber 300 AAC . . . . . (#7833023)
- Single Caliber 450 Bushmaster . . . . . (#7833026)
- Single Caliber 458 SOCOM . . . . . (#7833027)
- Single Caliber 50 Beowulf . . . . . (#7833028)
- Single Caliber 9mm Luger . . . . . (#7833029)
- Single Caliber 22-250. . . . . (#7833040)
- Single Caliber .243 Win . . . . . (#7833041)
- Single Caliber 6.5 Grendel . . . . . (#7833042)
- Single Caliber 270 Win. . . . . (#7833043)
- Single Caliber 30-06. . . . . (#7833044)
- Single Caliber 7.62x39. . . . . (#7833045)

**Multiple Blocks (Shown at left)**

- Ammo Checker Multiple Block 9mm . . . . . (#7833032)
- Ammo Checker Multiple Block 45ACP . . . . . (#7833033)
- Ammo Checker Multiple Block .223 Rem. . . . . (#7833034)

**Mag 25 Digital Melting Furnace**



Lyman has introduced their largest and most precise lead melting furnace yet: The Mag 25. The twenty five pound capacity is five pounds greater than Lyman's popular Mag 20. In addition, this new furnace is the first to offer an advanced digital thermal management system with key pad controls

Designed for the high volume bullet caster, the Mag 25 offers an array of features not found on any other furnace. With 850 watts of power, the furnace is quick to heat up, even with the increased capacity. In addition, the digital display on the front panel shows both the actual lead temperature as well as the desired temperature setting. Precise furnace operation is enhanced by the simple keypad controls.

For casting versatility, the furnace is equipped with a universal mould guide which can adjust for most popular mould blocks from Lyman, RCBS, Redding/Saeco & Lee. Lyman's proven bottom pour valve system and mould block preheating plate assure maximum casting volume.

The Mag 25 sits on a large, stable base with two, front-loading storage compartments for handy access to needed tools. This advanced furnace is offered in both 115 Volt and 230 Volt models.

- Advanced digital thermostat control with simple to use key pad
- Separate digital displays for temp. setting and actual lead temp.
- Larger 25 pound capacity
- Universal mould guide accepts most Lyman, RCBS, Redding/Saeco and Lee moulds
- Built-in storage compartment
- Powerful 850 watt heating system for fast warm-up
- Warming shelf for pre-heating mould blocks
- Reliable bottom pour valve system for increased bullet production

Mag 25 Digital Furnace 115V ..... (#2800382)  
 Mag 25 Digital Furnace 230V ..... (#2800386)



**Largest Capacity,  
 Digital Accuracy  
 and Control**

**Mag 25 is designed  
 to work with Lyman,  
 RCBS, Redding, and  
 Lee Mould Blocks.**



**WARNING:** Melting lead and casting lead objects will expose you and others in the area to lead, which is known to cause birth defects, other reproductive harm and cancer. See Instructions on Reducing Exposure supplied with product.

**Lyman's "Master Casting Kit"**

**The Best Way to Get Started in Bullet Casting.**



The kit's low price includes Lyman's popular improved 4500 Bullet Sizer/Lubricator. Simply add the right top punch and sizing die and the 4500 will smoothly size down your bullet to the correct diameter while it evenly applies the provided Super Moly Lubricant.

Kit Includes:

- Big Dipper
- 4500 Sizer/Lubricator
- Long handled casting dipper
- Ingot mould
- Super Moly Bullet Lube
- Lyman Cast Bullet Handbook

All this for less than the price of most casting furnaces.

Master Casting Kit 115V ..... (#2712000)



**For pricing visit our website  
[www.lymanproducts.com](http://www.lymanproducts.com)**

**WARNING:** Cancer and Reproductive Harm  
[www.p65warnings.ca.gov](http://www.p65warnings.ca.gov)



**4500 Lube Sizer**



The 4500 Lube Sizer features solid one piece bottom casting, heating elements to fit both 115 volt and 230 volt, and a longer ball knob handle for more leverage for sizing and lubricating the largest bullets. Includes gas check seater and Super Moly Lube.

- No Heater . . . . . (#2745880)
- With Heater 115V . . . . . (#2745892)
- Heating Element 115V . . . . . (#2745896)

*Available with or without built-in heater*



**Gas Check Seater**

This ingenious, unique device allows consistent, square seating of gas checks. Works on all Lyman #450, 4500 Sizer/Lubricators and RCBS Lube-A-Matic. Seater (4 oz.) . . . . . (#2745881)

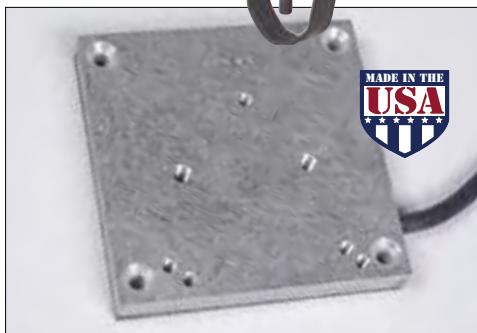

**Universal Lube Heater Accessory**

Designed for today's high temperature lubes, this heats the Lube/Sizer to the right temperature for smooth, effortless bullet lubrication. The mounting plate is drilled and tapped for Lyman 450, RCBS, Saeco and Star Lube/Sizers. Plugs into standard 110 volt outlet (comes complete with mounting hardware). Note: Do not confuse with 4500 heating element.

- 115V . . . . . (#2745885)

**Orange Magic™ Premium Bullet Lube**



This hard lubricant is guaranteed to provide higher velocities with cast pistol and rifle bullets without leading. It will not melt out of loaded ammunition at high temperatures. (Recommended for use with the Lyman Lube Heater.)

- Orange Magic Lube: . . . . . (#2857286)

**Super Moly Bullet Lube**



The Molybdenum Disulfide in this lube coats the barrel for increased velocity and improved accuracy. In addition, it virtually eliminates leading and it flows through lube sizers without heat, yet won't melt at 130°.

- Super Moly Lube: . . . . . (#2857272)

All Lyman stick lubricants are in a tube, fit the 4500 Sizer/ Lubricator and similar Sizing/Lubricating tools, including RCBS.

**WARNING:** Cancer and Reproductive Harm  
www.p65warnings.ca.gov



**Digital Lead Thermometer**



The Lyman Digital Thermometer is a fast and accurate way to check the temperature of your casting alloy. The long 6" probe will work with the largest casting furnaces and keeps your hand away from molten lead. The large, easy to read display can be set for Fahrenheit or Celsius and also features a hold button to lock a reading on the display.

- Fast and Accurate
- 6" Long Probe to Work with Large Furnaces
- Easy to Read Display
- Fahrenheit or Celsius

Digital Lead Thermometer (#2867797)



**Black Powder Gold™ Lube**



Formulated for long range black powder shooting. It keeps fouling soft and flows through lube sizers. It can be applied by hand to muzzleloading bullets.

- Black Powder Gold Lube: . . . . . (#2857266)

**Lyman Alox Lube**



This is the original NRA formula developed for increased cast bullet velocities.

- Alox Lube (1 1/4 oz stick) . . . . . (#2857277)

**Lyman Ideal Lube**



A great all-purpose lube.

- Ideal Lube (1 1/4 oz stick) . . . . . (#2857275)

**For pricing visit our website**  
[www.lymanproducts.com](http://www.lymanproducts.com)

**“Big Dipper” Electric Casting Furnace**



This economical electric casting furnace has more than 10 lb. Capacity. Features fast heat-up time with heat control to +/- 10 degrees. Easy “on-off” temperature dial. Compact size with wide mouth for easy ladling. Heavy duty aluminum construction with stable non-tip design. (115 Volt)

- Big Dipper Electric Casting Furnace 115V ..... (#2800350)
- Big Dipper Electric Casting Furnace 230V ..... (#2800355)



**Includes  
Cast Bullet  
Handbook**

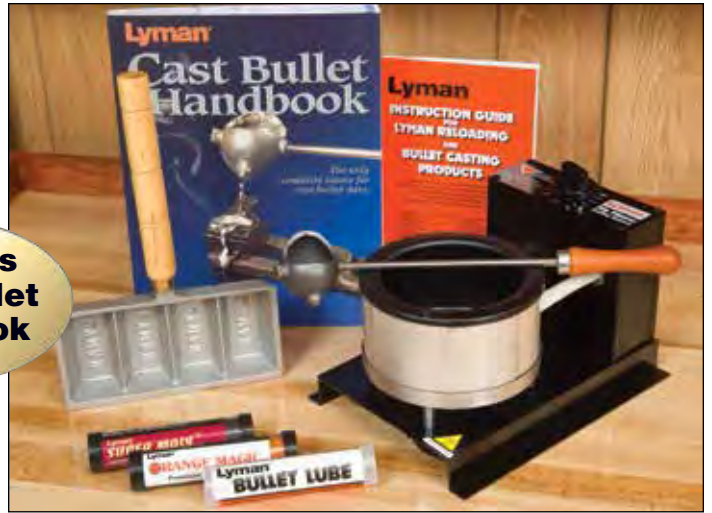

**“Big Dipper” Casting Starter Kit**



Features all the items needed to get started in casting bullets economically and efficiently. Includes “Big Dipper” electric casting furnace with 10+ lbs capacity, Lyman Casting Dipper, Ingot Mold for storing excess lead, Super Moly Bullet Lube, Orange Magic Bullet Lube, Alox Bullet Lube, and the Lyman Reloading and Cast Bullet Guide. Big Dipper Casting Kit 115V ..... (#2800375)  
Big Dipper Casting Kit 230V ..... (#2800378)

**10lb. Cast Iron Lead Pot**



10lb. capacity, made of cast iron with convenient pour spout. Lyman’s lead pot allows the bullet caster to use any source of heat for melting his lead alloy. Nominal pot capacity is ten pounds of alloy. Flat bottom prevents tipping.

- 10lb. Cast Iron Lead Pot ..... (#2867795)



**A. Casting Ingot Mould**



Useful when melting down scrap lead, emptying your furnace, or when blending alloys. Each mould forms four, easy-to-use ingots that stack easily and will weigh approximately 1 lb. Sides of mould have 30° draft for easy ejection of lead ingots.

- Ingot Mould (1 lb.) ..... (#2837794)

**B. Casting Dipper**



Our dipper with cast iron head is shaped for easy, accurate pouring and prevents air pockets in the finished bullet. The long stem dipper can also be used for stirring molten lead alloys. Wooden handle stays cool in use. Can be set up for right- or left-hand use.

- Casting Dipper (6 oz.) ..... (#2867790)

**C. Casting Thermometer**



This stainless steel thermometer will measure a temperature range from 200°F to 1000°F and has a six inch stem for use with even the deepest furnaces.

- Casting Thermometer (4 oz.) ..... (#2867793)



*Dipper can be assembled for either right- or left-hand use!*

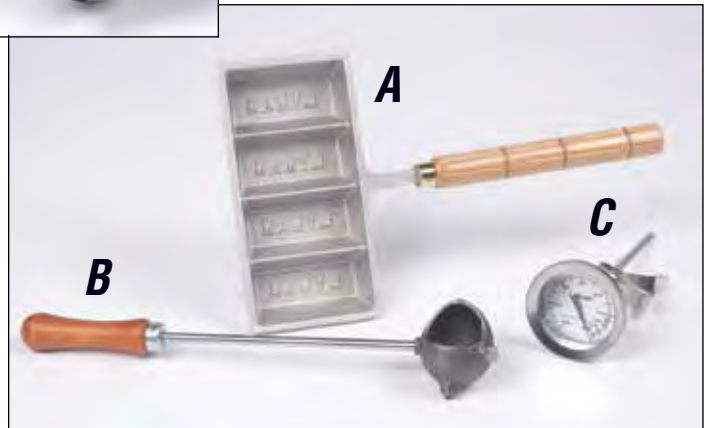

**Sizing Dies**

Lyman improved sizing dies now have 90° hole spacing. It's now easy to lubricate bullets even with today's hard lubricants. Lyman sizing dies also feature a tapered mouth and hardened interior insuring alignment for perfect cylindrical shape. Interior dimensions correspond to suggested diameters for all popular rifle and pistol calibers. Refer to the chart below for proper size. Lyman Top Punches are precisely machined to fit bullet nose shape exactly. This eliminates nose deformation. Refer to Lyman's bullet mould listing for suggested top punch number. (These are interchangeable with RCBS)



**Lyman Sizing Die Diameter Chart**

Dia.	Part No.	Dia.	Part No.	Dia.	Part No.
.224	2766462	.323	2766486	.409	2766550
.225	2766463	.325	2766487	.410	2766505
.243	2766542	.338	2766488	.413	2766506
.244	2766465	.354	2766534	.427	2766508
.251	2766460	.355	2766490	.428	2766537
.257	2766466	.356	2766491	.429	2766509
.258	2766467	.357	2766492	.430	2766510
.264	2766543	.358	2766493	.431	2766511
.266	2766470	.359	2766494	.439	2766541
.277	2766551	.360	2766495	.446	2766513
.278	2766471	.363	2766559	.450	2766514
.284	2766552	.375	2766497	.451	2766515
.285	2766473	.377	2766527	.452	2766516
.308	2766476	.378	2766524	.454	2766517
.309	2766477	.379	2766498	.457	2766519
.310	2766478	.380	2766499	.458	2766535
.311	2766479	.381	2766500	.459	2766530
.312	2766528	.400	2766501	.501	2766525
.313	2766480	.401	2766502	.509	2766520
.314	2766553	.406	2766504	.512	2766521
.321	2766485	.408	2766548		

**Suggested and Alternative Sizing Die Diameters**

Pistol Caliber	Dia. (inches)
.22 Jet, .221 Fireball	.224*, .225
25 ACP	.251*
.25 cal.	.257*, .258
.30 Luger, 30 Herritt, 30 Mauser	.310*
.32 ACP, .32/20, .32 S&W, .32 H&R Magnum	.311, .312, 313*, .314
9mm Luger*, .38, .38 Super Auto, .380 Auto	.354, .355*, .356
38 S&W, .38 Spl., 357 Mag.*, .357 Max.	.357, .358*, .359, .360
9mm Makarov	.363
.38/40, 10mm Auto, 40 S&W	.400*, .401
.41 S&W Mag., 41 Action Express	.410*
44 S&W Spl., 44 Mag.*, 44 Russian	.429*, .430, .431
45 ACP, .45 Auto Rim, .45 Colt* (post-WW II), .45 Sch. .45 Win. Mag.	.450, .451*, .452
.45 Colt (pre-WW II) & .455 Webley	.454*
500 S&W	.501
Rifle Caliber	Dia. (inches)
.22 cal. (except .22 Hi-power)	.224, .225*
.243, .244, 6mm	.243, .244*
.25 cal.	.257, .258*
.264 Win. Mag., 6.5mm	.264*, .266
.270 Win.*	.277, .278*
7mm, .280 Rem., .284 Win.	.284, .285*
.30 cal.	.308, .309*, .310
7.62mm Russian*	.310
.32/20 Win.	.311, .312*
7.65mm Mauser*	.311
.303 British*, 7.7mm Jap.*	.313, 314*
.32 Win. Spec. 32 S.L., .32 Rem.	.321
8mm Mauser (S Bore)	.323, .325*
.338 Win., .33 Win.	.338*
9mm x 56, 9mm x 57	.354, .355*, .356
.35 Cal.	.357, .358*, .359
.375 H&H Mag., .375 Win.	.375, .377*, .378
.38/55*	.379
.38/40	.400, 401*
40 Cal. Rifle	.406, 410
.44/40	.427, .428*
.44 Spl., .44 Magnum	.429, 430*
.444 Marlin	.430, .431*
.43 Spanish	.439
.45/70, .458 Win.	.457, 458*, .459
.50 Cal. Rifle	.509, .512*

\* Wide variations in diameter. Suggest you slug barrel.

\*Indicates suggested useful diameter, which may vary from gun to gun.

**Gas Checks**



These gilding metal cups fit the cast bullet base and protect it from hot powder gases. Easily seated during bullet sizing, the gas checks also permit higher velocities.

Specify caliber: (1000 per pack)

Cal.	Part No.
.22	2827261
.25	2827263
.264 (6.5mm)	2827264
.284 (7mm)	2827266
.30	2827267
.32 (8mm)	2827268
.35 (.38 Spl. & .357)	2827270
.375	2827271
.44	2827272
.45	2827273



**Lyman Mould Rebuild Kit**



With proper care, a Lyman mould will last for generations. Rebuild kits provide replacement of those moving parts which may tend to wear after long use. Includes sprue cutter, washer, all screws for block and handle.

Large single cavity kit (2 oz.)	(#2680100)
Double cavity kit (2 oz.)	(#2680102)
Four cavity kit (6 oz.)	(#2680104)

**Mould Box**

Spare mould box is made of tough plastic with a snap-lock cover. Impervious to moisture, bore cleaner or oil. Includes blank label. Fits single and double cavity moulds only.

(3 oz.)	(#2735790)
Ten Pack (1 3/4 lbs.)	(#2735789)



**WARNING:** Cancer and Reproductive Harm  
www.p65warnings.ca.gov

**For pricing visit our website**  
[www.lymanproducts.com](http://www.lymanproducts.com)

## Pistol Moulds



Our standard offering of pistol moulds covers popular bullet designs, in double cavity style. Four cavity blocks for selected designs are also shown in the table below. Refer to the Devastator Hollow Point section for availability. Double and single cavity mould blocks less handles (12 oz.) Four-cavity mould block, less handles (2 lbs., 3 oz.)



### Symbol Key

- Cowboy Action Moulds
- Recommended for use on silhouettes
- Use 30 cal. gas check.
- EK** Indicates Elmer Keith Design.
- RT** Indicates Ray Thompson Design.
- GE** Indicates Gould Express bullet designed by John Barlow.
- ES** Indicates designed by Ed Schmitt.
- PM** Indicates designed by Paul Matthews.
- ★ Indicates single cavity mold.

Pistol	.30	.32	9mm				.38/.357		RT	ES
<b>Bullet Number</b>	311252	313249	356242	356402	356242	356637	358091	358477	358156	358665
<b>Weight (#2 Alloy)</b>	75 gr.	85 gr.	90 gr.	120 gr.	120 gr.	147 gr.	150 gr.	150 gr.	155 gr.	158 gr.
<b>Double Cavity Part #</b>	2660252	2660249	2661242	2660402	2660242	2660637	—	2660477	2660156	2660665
<b>Four Cavity Part #</b>	—	—	—	2670402	—	2670637	2670091	2670477	2670156	2670665
<b>Top Punch Number</b>	465	226	311	402	311	637	495	429	429	495
<b>Top Punch Part #</b>	2786742	2786703	2786710	2786723	2786710	2786749	2786769	2786731	2786731	2786769



### New Pistol Moulds

#358439 – Lyman returns a famous Elmer Keith design to our mould line. Mould #358439 is Keith's extremely popular #358429 but in a hollow point version. The lighter weight hollow point bullet provided Keith with more velocity and expansion.



★  
**358439**  
 155 gr.  
 2650439  
 —  
 429  
 2786731

#429303 – Designed by Carl F. Hudson, he called it “Hi-Velo-Pen” for high velocity and penetration. In the 1958 Lyman Cast Bullet Handbook, Mr. Hudson states, “It passes through 3/16” steel plate as no other 44 has done for me”.

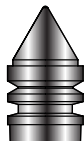

**429303**  
 200 gr.  
 2660303  
 —  
 303  
 2786709

### .38/.357



**358311**  
 160 gr.  
 not available  
 2670311  
 311  
 2786710

**358429**  
 170 gr.  
 2660429  
 2670429  
 429  
 2786731

**358430**  
 195 gr.  
 2660430  
 —  
 430  
 2786732

### 40 S&W/10mm



**401654**  
 150 gr.  
 2660654  
 —  
 43  
 2786691

**401638**  
 175 gr.  
 2660638  
 2670638  
 43  
 2786691

### .44/40



★  
**427666**  
 200 gr.  
 2660666  
 —  
 649  
 2786778

### .44



**429215**  
 210 gr.  
 2660215  
 2670215  
 421  
 2786729

**429667**  
 240 gr.  
 2660667  
 —  
 649  
 2786778

**429421**  
 245 gr.  
 2660421  
 2670421  
 421  
 2786729

**429383**  
 245 gr.  
 2660383  
 —  
 251  
 2786704

**429244**  
 255 gr.  
 2660244  
 2670244  
 421  
 2786729

**429650**  
 300 gr.  
 2660650  
 —  
 421  
 2786729

### .45 Auto



**452460**  
 200 gr.  
 2660460  
 2670460  
 460  
 2786740

**452630**  
 200 gr.  
 2660630  
 2670630  
 460  
 2786740

**452374**  
 225 gr.  
 2660374  
 2670374  
 374  
 2786719

### .45 Colt .454 dia.



**454190**  
 250 gr.  
 2660190  
 —  
 190  
 2786700

### .452 dia.



**452664**  
 250 gr.  
 2660664  
 2670664  
 649  
 2786778



**452424**  
 255 gr.  
 2660422  
 —  
 424  
 2786730



**452490**  
 255 gr.  
 2660490  
 —  
 424  
 2786730

### .45

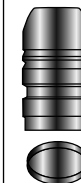

**452651**  
 325 gr.  
 2660651  
 —  
 649  
 2786778

### 500 S&W



★  
**501680**  
 375 gr.  
 2640680  
 —  
 649  
 2786778

NOTE: All standard rifle and pistol moulds use handles #2735793, and four-cavity moulds use handle #2735794. Bullet weights listed are nominal and may well vary from bullets dropped from a given mould. Variations between listed nominal weights and actual as-cast weights have absolutely no effect on accuracy. These bullet illustrations are artists' renderings. They are for general reference only and are not intended to be precise representation.

### Devastator Hollow Point Moulds

38 spec./9 mm	.44 ★	.45
★ 	★ 	★ 
<b>356637</b> 125 gr. 2650637 637 2786749	<b>429640</b> 250 gr. 2650640 649 2786778	<b>452374</b> 180 gr. 2650374 374 2786719

★ Indicates single cavity.



**WARNING:** Cancer and Reproductive Harm  
[www.p65warnings.ca.gov](http://www.p65warnings.ca.gov)











## Rifle Moulds







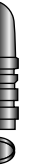





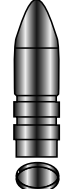
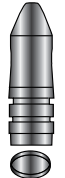
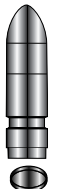
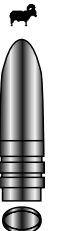



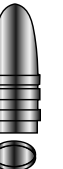

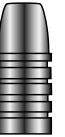
Lyman rifle moulds are the standard by which all other rifle moulds are judged. The designs shown below picture gas checks where appropriate. All Lyman rifle moulds are available in double cavity only, except those moulds where the size of the bullet necessitates a single cavity (indicated below by a ★). All rifle moulds shown below require double cavity handles, regardless of the number of cavities indicated. Hollow point designs are noted above bullet. Rifle Moulds (13oz.) mould, less handles











**WARNING:** Melting lead and casting lead objects will expose you and others in the area to lead, which is known to cause birth defects, other reproductive harm and cancer. See Instructions on Reducing Exposure supplied with product.



Rifle	.22			.25	6.5mm	.30 M1/ 7.62x39mm				
										
Bullet Number	225438	225415	225646	257420	266469	311359	311410	311672	311291	311041
Weight(#2 Alloy)	44 gr.	55 gr.	55 gr.	65 gr.	140 gr.	115 gr.	130 gr.	160 gr.	170 gr.	173 gr.
Mould Number	2660438	2660415	2660646	2660420	2660469	2660359	2660410	2660672	2660291	2660041
Top Punch Number	438	415	646	420	463	359	467	644	465	8
Top Punch Part #	2786733	2786726	2786759	2786728	2786741	2786772	2786743	2786758	2786742	2786690

	 .30		 .30		32/20	.314 dia.	32/40	8mm	35	
										
Bullet Number	311332	311644	311679	311299	311284	311008	314299	319247	323470	358315
Weight(#2 Alloy)	180 gr.	190 gr.	195 gr.	200 gr.	210 gr.	115 gr.	200 gr.	165 gr.	165 gr.	204 gr.
Mould Number	2660332	2660644	2660679	2661299	2660284	2660008	2660299	2660247	2660470	2660315
Top Punch Number	413	644	359	467	284	8	467	8	470	311
Top Punch Part #	2786725	2786758	2786772	2786743	2786707	2786690	2786743	2786690	2786745	2786710

	.381 dia.	.375 dia.	.378 ★ .38-55	.40 Cal. .406 dia.	.40 Cal. ★ .410 dia.	★	43 Span.	43 Mauser ★	45	★
										
Bullet Number	380681	375449	378674	403169	410660	410663	439186	446110	457130	457191
Weight(#2 Alloy)	250 gr.	264 gr.	335 gr.	240 gr.	385 gr.	400 gr.	370 gr.	340 gr.	145 gr.	292 gr.
Mould Number	2660681	2660449	2640674	2660169	not available	2640663	2640186	2640110	2660130	2640191
Top Punch Number	449	449	663	43	658	663	251	251	130	191
Top Punch Part #	2786736	2786736	2786779	2786691	2786755	2786779	2786704	2786704	N/A	2786701

	45 H.P. ★ GE	★	★	★	★	★ ES	★ PM	★	Postell ★	.50 ★	★
											
Bullet Number	457122	457124	457643	457193	457671	457658	457677	457125	457132	515139	515141
Weight(#2 Alloy)	330 gr.	385 gr.	400 gr.	405 gr.	475 gr.	480 gr.	490 gr.	500 gr.	535 gr.	340 gr.	425 gr.
Mould Number	2650122	2640124	2640643	2640193	2640671	2640658	2640677	2640125	2640132	2640139	2640141
Top Punch Number	191	374	191	191	374	658	677	374	132	191	141
Top Punch Part #	2786701	2786719	2786701	2786701	2786719	2786755	2786781	2786719	2786695	2786701	2786696









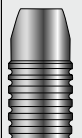

**WARNING:** Cancer and Reproductive Harm  
www.p65warnings.ca.gov

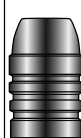
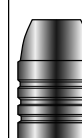
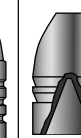
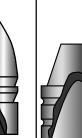
For pricing visit our website  
[www.lymanproducts.com](http://www.lymanproducts.com)

## WARNING:

Melting lead and casting lead objects will expose you and others in the area to lead, which is known to cause birth defects, other reproductive harm and cancer. See Instructions on Reducing Exposure supplied with product.

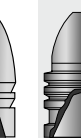
	<b>.45 Conical</b>		<b>Plains Bullets</b>		<b>Minié Ball</b>						<b>Maxi Ball</b>		
	Volunteer .451	Whitworth .45	.50	.54	.54	.58	Old Style	New Style	Parker Hale	Blue-Gray Target	.45	.50	
													
<b>Bullet #</b>	451114	457121PH	508656	548657	542622	575494	575213-OS	575213-NS	575213-PH	577611	578675	454616	504617
<b>Wt. (Lead)</b>	450 gr.	475 gr.	395 gr.	450 gr.	425 gr.	315 gr.	460 gr.	510 gr.	566 gr.	530 gr.	405 gr.	245 gr.	370 gr.
<b>Mould #</b>	2641114	2641121	2654656	2654657	2654622	2654494	2654213	2651213	2650213	not available	2654675	2640616	2640617
<b>Handles #</b>	2735793	2735793	2735793	2735793	2735793	2735793	2735793	2735793	2735793	2735793	2735793	2735793	2735793

### Round Ball Moulds

Throw perfect, ball after ball, with a minimum sprue to ensure the kind of accuracy that target shooters have come to expect from Lyman precision moulds. Round Ball Moulds (14 oz.)



### Round Ball Suitability Chart

Ball Diameter	Single Cavity Part #	2 Cavity Part #	Common Usage
*.375(P)	—	2665375	.36 Caliber
.445	—	2665445	.45 Caliber
.451(P)	—	2665451	.44 Caliber
.454(P)	—	2665454	.44 Caliber
.457(P)	—	2665457	.45 Ruger
*.490	—	2665490	.50 Caliber
.495	—	2665495	.50 Caliber
.535	2645535	—	.54 Caliber
*.570	2645570	—	.58 Caliber
.600	2645600	—	
.662	2645662	—	12 GA
*.715	2645715	—	.75 Caliber
.735	2645735	—	

\*Recommended size depending on bore diameter.  
(P)Recommended for percussion revolvers.  
§NOTE: All single cavity round ball moulds take double cavity handles.

### .45 Conical & Plains Bullets

These offer the traditional muzzleloader a tapered bullet design for easy loading. Large deep lube grooves hold enough lube to keep fouling soft and ensure accuracy without leading. Plains Bullets (14 oz.)





### Minie and Maxi Mould

These designs are exactly reproduced from originals used over 100 years ago. The best bullets selected from American and British designs from 45 to 69 caliber. Minie and Maxi Mould (14 oz.)



### Uses Standard Plastic Wad

	
<b>20 ga.</b> 350 gr. 2654120	<b>12 ga.</b> 525 gr. 2654112
Use with STD Wads	

### Lyman Shotgun Sabot Slug



Lyman Sabot slugs are designed to fit standard shotgun wads and star crimped. No special roll crimping tools necessary. Loading data available in the Lyman Shotshell Handbook 5th Edition for 12 ga.  
12 GA Sabot ..... (#2654112)  
20 GA Sabot ..... (#2654120)

### Shotgun Slugs

	
<b>20 ga.</b> 345 gr. 2654020	<b>12 ga.</b> 475 gr. 2654012

### Shotgun Slug Moulds



Available in 12 or 20 gauge, these moulds cast perfect hollow base slugs which do not require rifling. Slug moulds are single cavity only and cut into the larger double cavity block. They require double cavity handles. Shotgun Slug Moulds (14oz.)



### Mould Handles



Solid metal frame is easily attached to blocks with slotted screws. Hardwood handles provide a cool secure grip. Designed to provide uniform grip with different mould blocks.

Lyman mould handles are offered in two sizes.  
Double-cavity handles (12 oz.) ..... (#2735793)  
(for all current two-cavity and single cavity moulds)  
Four-cavity handles (1 lb.) ..... (#2735794)



# MODEL of 1878

*Lyman & Pedersoli  
combine forces  
on a truly  
unique rifle.*



## Lyman® “Model of 1878” Sharps Rifle

### The Ultimate Refinement of the Side-Hammer Sharps

As the buffalo era was ending, Sharps refined their renowned rifle to create the rare 1877 Model. It was often referred to as the “English Model” not just due to its refined styling but for its high quality English-made barrels. This would be their last side-hammer model. More streamlined, the ‘77 was more of a hunting/target rifle and less of a heavy buffalo gun. It was the most advanced single shot of the day. A year later William Lyman introduced his now famous Tang Sight.

Reproduced for today’s single shot enthusiast, Sharps’ final iconic side-hammer design and Lyman’s sights combine to create Lyman’s “Model of 1878”. Pains-takingly crafted to Lyman’s specifications by Pedersoli of Italy, this rare model has only been reproduced as an expensive, custom-made gun, until now. Lyman has changed that with a rifle that’s packed with features that assure tack-driving performance.

First and foremost, Pedersoli’s renowned craftsmanship and premium quality 45/70 barrel work in conjunction with the double set triggers and Lyman’s tang and globe sights for a complete accuracy system. The butt stock has the faster mounting and more comfortable “shotgun-style” butt and the forend is finished with a premium ebony tip. Both carry tasteful, functional checkering patterns. Period style, laser engraving adds additional elegance to the receiver and lockplate. Overall, Lyman’s Model of 1878 is a unique and desirable addition to any single shot enthusiast’s collection.

**Cannot be sold without an FFL.**

Model of 1878 ..... (#6001878)



**Great Plains™ Rifle**

Originally designed and built by such famous makers as Hawken, Gemmer and Demick, Great Plains rifles were the best and most reliable designs and finest workmanship available. No other factory assembled rifle or kit offers the authentic style and design of Lyman's Great Plains Rifle. This classic muzzleloader offers such high quality features as a 32" barrel with 1 in 60" twist for patched ball and hunting loads, double set triggers, Hawken style percussion "snail" with clean out screw, separate ramrod entry thimble and nose cap, and reliable coil spring lock with correct lock plate. Available in .50 and .54 caliber flint or percussion. Factory assembled or kit form.

- 50 Cal. Percussion 1 in 60" ..... (#6031102)
- 54 Cal. Percussion 1 in 60" ..... (#6031103)
- 50 Cal. Percussion Left Hand 1 in 60" ..... (#6031125)
- 54 Cal. Percussion Left Hand 1 in 60" ..... (#6031126)
- 50 Cal. Flintlock 1 in 60" ..... (#6031105)
- 54 Cal. Flintlock 1 in 60" ..... (#6031106)
- 50 Cal. Flintlock Left Hand 1 in 60" ..... (#6031137)

- Great Plains Kits
- 50 Cal. Percussion 1 in 60" ..... (#6031111)
  - 54 Cal. Percussion 1 in 60" ..... (#6031112)
  - 50 Cal. Flintlock 1 in 60" ..... (#6031114)
  - 54 Cal. Flintlock 1 in 60" ..... (#6031115)

**Attention All Great Plains™ Rifle Owners:**

Get the most out of your Great Plains rifle with a "Hunter" Barrel (1 in 32" twist) that converts your rifle to shoot today's modern conical and sabot bullets. If you own a Great Plains Rifle, with a Classic 1 in 60" twist, just install an optional Hunter Barrel and you're ready for hunting season. A fitted tang for easy change over is included, along with original gun's factory installed sights.

- 50 Cal Perc 1 in 32" ..... (#6030266)
- 54 Cal Perc 1 in 32" ..... (#6030267)
- 50 Cal Flint 1 in 32" ..... (#6031108)
- 54 Cal Flint 1 in 32" ..... (#6031109)
- 50 Cal Flint 1 in 60" ..... (#6030198)
- 54 Cal Flint 1 in 60" ..... (#6030199)
- 50 Cal Perc 1 in 60" ..... (#6030221)
- 54 Cal Perc 1 in 60" ..... (#6030222)

**Discover the Interchangeable Barrel System by Lyman.**

Shoot your current gun in a new caliber for bigger game. Choose the caliber that meets your shooting needs. Easy "drop-in" design. Change your twist or caliber with the barrel that meets your needs.

**"Fast-Twist" Drop-In Barrels For Great Plains™ Rifles**

Round Ball (1-60" twist) Barrels in both .50 and .54 caliber are also available, contact Lyman customer service for more information.



**Left Handed Shooters Alert**

Check listing for Left Hand models available for both Deerstalker and Great Plains™ Rifle lines. Call customer service for details.

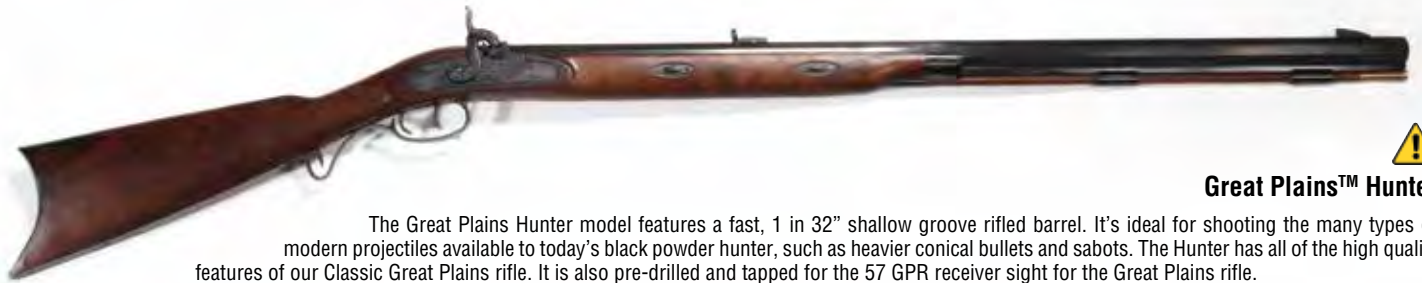

**Great Plains™ Hunter**

The Great Plains Hunter model features a fast, 1 in 32" shallow groove rifled barrel. It's ideal for shooting the many types of modern projectiles available to today's black powder hunter, such as heavier conical bullets and sabots. The Hunter has all of the high quality features of our Classic Great Plains rifle. It is also pre-drilled and tapped for the 57 GPR receiver sight for the Great Plains rifle.

- 50 Cal. Percussion 1 in 32" ..... (#6031120)
- 54 Cal. Percussion 1 in 32" ..... (#6031121)
- 50 Cal. Flintlock 1 in 32" ★ ..... (#6031148)
- 50 Cal. Perc. Left Hand 1 in 32" ..... (#6031142)

**★Great Plains™ Hunter in Flintlock (1 in 32" twist) is the ideal model for the Pennsylvania Special Flintlock Season**

Model	Caliber	Twist Rate	Barrel Length	Over-all Length	Length of Pull	Weight
1878 Sharps	45-70	1-18"	30"	47"	14"	9 lbs
Great Plains™	50/54	1-60"	32"	50"	14"	9 lbs
Great Plains™ Hunter	50/54	1-32"	32"	50"	14"	9 lbs
Trade Rifle	50/54	1-48"	28"	46"	14"	8 lbs
Deerstalker	50/54	1-48"	24"	41"	14"	7.5 lbs
Plains Pistol	50/54	1-30"	8"	14.5"	NA	3 lbs

**For pricing visit our website  
www.lymanproducts.com**

**WARNING:** Cancer and Reproductive Harm  
www.p65warnings.ca.gov





**Lyman® Trade Rifle**



The Lyman Trade Rifle is patterned after the sturdy and functional guns developed for the early Indian fur trade. Designed by such companies as Henry and Leman, these original guns were much sought after by trappers, Indians and other rugged wilderness survivors. Drop in barrels are also available.

- 50 Cal. Perc 1 in 48" ..... (#6032125)
- 50 Cal. Flint 1 in 48" ..... (#6032129)
- 54 Cal. Perc 1 in 48" ..... (#6032126)
- 54 Cal. Flint 1 in 48" ..... (#6032130)



**Deerstalker Rifle**



Lyman's Deerstalker Rifle has quickly earned the reputation as one of America's most reliable, accurate and affordable hunting muzzleloaders. All Deerstalkers have "Guaranteed" performance features such as a quiet single trigger, reliable coil mainspring and high quality Lyman fiber optic sights. The 24" barrel with 1 in 48" twist is ideal for roundball or maxi hunting bullets. Parts are blackened to avoid glare and a black rubber recoil pad mounted on the Deerstalker's handsome hardwood stock, makes for comfortable shooting in either .50 or .54 caliber. Drop in barrels available.

- .50 Cal. Perc 1 in 48" ..... (#6033140)
- .50 Cal. Flint 1 in 48" ..... (#6033146)
- .54 Cal. Perc 1 in 48" ..... (#6033141)
- .54 Cal. Flint 1 in 48" ..... (#6033147)
- .50 Cal. Flint 1 in 48" Left Hand ..... (#6033171)



**Lyman® Plains Pistol**



Lyman Plains Pistol recreates the trapper's pistol of the mid-1800's while incorporating the best of modern steels and technology. It's the perfect companion to a Lyman black powder rifle. This percussion pistol is loaded with quality features. The richly stained walnut stock complements blackened iron furniture, polished brass trigger guard and ramrod tips. The hooked patent breech takes down quickly and easily for cleaning. Just like the originals, the thimble is recessed into the rib and a detachable belt hook provides an alternative to a holster.

A spring-loaded trigger and fast 1 in 30" twist make it amazingly accurate.

- 50 Cal. Perc 1 in 30" ..... (#6010608)
- 54 Cal. Perc 1 in 30" ..... (#6010609)
- 50 Cal. Perc "Kit" 1 in 30" ..... (#6010610)
- 54 Cal. Perc "Kit" 1 in 30" ..... (#6010611)



**To Keep Your Muzzleloader Clean and Functioning Properly, Try our Butch's Black Powder Bore Shine and our Lyman Pick & Brush Set for cleaning**

Butch's Black Powder Bore Shine 8oz. Page 55 (#02949)  
Pick and Brush Set Page 53 (#04038)



**Lyman Black Powder Accessories**



- Unbreakable Ramrod fits barrels up to 36" (#6010030)
- Flint Frizzen ..... (#6030182)
- Rifle Flints 2-pack ..... (#6030106)
- Rifle Nipple 3-pack (stainless) ..... (#6030080)
- Touch Hole Liner ..... (#6030176)
- Wedge Trade Rifle ..... (#6030142)
- Wedge Deerstalker ..... (#6993112)
- Wedge Great Plains ..... (#6030196)
- Rifle Nipple Wrench ..... (#6030105)

**PRODUCT SAFETY WARNING AND RECALL NOTICE**

Lyman Products Corp. has voluntarily recalled black powder rifles and pistols due to the potential of separation in the breech plug. Lyman maintains a safety-first approach, so despite finding only a few firearms affected and no reported injuries, we are offering a recall program to have the issue corrected. Lyman regrets the inconvenience but remains committed to the safety of our customers.

This recall includes black powder rifles and pistols regardless of caliber (including Deerstalker, Great Plains, Great Plains Hunter, Trade Rifle, Plains Pistol, Black Powder Kits, and replacement barrels; excluding Percussion Left Hand Great Plains and Left Hand Great Plains Hunter models) manufactured from March 1, 2017 to December 22, 2017. Barrels with the serial number in the range of A595960-A599026 are subject to this recall.

To check your serial number, please go to:  
<https://www.lymanproducts.com/recall>  
or contact customer service at 860-632-2020

**WARNING:** Cancer and Reproductive Harm  
[www.p65warnings.ca.gov](http://www.p65warnings.ca.gov)

**For pricing visit our website**  
[www.lymanproducts.com](http://www.lymanproducts.com)



## '73 Uberti No. 2 Tang Sights

This No. 2 Sight is all steel construction and features height index marks on the aperture post, with a maximum elevation of .800 for long range shooting. It includes both a .093 quick sighting hunting aperture and a .040 Large Disk Target Aperture. Mounting screws and instructions are included. (Note: some rifles may require the drilling and tapping of the forward mounting screw.)  
 No. 2 Tang Sight (Model '73) ..... (#3902109)

## 1894 No. 2 Tang Sight

This model fits most new and old 94 models plus these other historic Winchester Models: 1892 and 1894. The No. 2 will also fit other models when adjusted to full height. (Note: does not fit new rifles with Tang safety).  
 (Win. 94 Pre 2003) ..... (#3902094)

## 1886 No. 2 Tang Sight

This legendary tang sight is also available for the Winchester 1886 lever action rifle. For original Winchester model 1886 and Browning replicas, it features height index marks on the aperture post and an .800 maximum elevation adjustment. Also included is a .093 x 1/2" quick-sighting aperture and .040 x 5/8" target disk. Mounting screws and instructions are included. (Note: does not fit new rifles with Tang safety).  
 (Winchester '86) ..... (#3902105)

## No. 2 Marlin Tang Sight

In 1995, Lyman introduced a new version of the No. 2 Tang for Marlin Models 336, 1894, 1895 and 30 series lever action rifles. The Marlin version features a special adapter base which allows mounting on the sight on the tang without damaging the serial number. All steel, this model has the same features and aperture discs as the 1886 model above. Mounting screws and instructions are included. (Marlin) ..... (#3902100)



## Henry Level Action Rifle No. 2 Tang Sight

Lyman is proud to announce the addition of a #2 Tang Sight for the popular Henry line of lever action rifles. Like our other folding tang sights, this new Henry model will feature all steel construction, elevation locking sleeves, and both hunting and target style apertures. The Henry #2 Tang Sight fits these models:

- H006 – Big Boy, Big Boy Carbine, Big Boy Silver
- H009 – All-Weather 30-30
- H010 – All-Weather 45-70
- H012 – Big Boy All Weather, Big Boy Steel
- H018 – Lever Action 410 Shotgun

Henry Level Action Rifle No. 2 Tang Sight (#3902095)

## Upgrade Your Muzzleloader with Lyman® Black Powder Sights

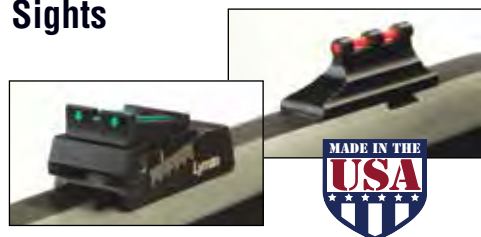

### Fiber Optic Hunting Sights

*Fits Most European Imported Muzzleloaders*

Now, black powder hunters can update their rifle sights with state-of-the-art fiber optic technology. These Lyman sights let hunters take advantage of every minute in the field. They are especially helpful in dawn and dusk periods when game is most active. Designed to fit the Lyman Great Plains™, Trade and Deerstalker Rifles; these bright, light-gathering sights will also fit most other European-made black powder rifles.

Fiber Optic Sights ..... (#3090145)

### 16AML and 37ML Hunting Sights

Tired of the same old traditional blade and buckhorn sights found on most muzzleloaders? These quality Lyman hunting sights will help an old gun shoot straight and true. Both have special .360 dovetail cuts that fit most European imports. The 16AML folding leaf sight is fully adjustable for elevation. The 37ML white bead front sight stands out in low light conditions.

- #16AML (Ht. .400-.500) ..... (#3090117)
- #37ML (Ht. .445) ..... (#3090118)
- Special Value: Combination Set ..... (#3090106)

## Lyman® 57SML & 57GPR Receiver Sights

The most popular black powder receiver sight offers an immediate improvement in accuracy for the target shooter or hunter. Features 1/4 minute micrometer click adjustments for elevation and windage, quick release slide. 57SML fits perfectly on Lyman Deerstalker or Trade Rifle. Other models may require minor drilling and tapping depending on manufacturer. 57GPR fits Great Plains™ supplied with adapter.

- 57SML (4 oz.) ..... (#3090114)
- 57GPR (4 oz.) ..... (#3090112)



57 SML, 57 GPR  
(for Great Plains™)

## Lyman® #17A Muzzleloader Front Sight

The ideal companion for the 57SML receiver sight, the 17 comes complete with a set of 8 interchangeable inserts (see Page 47). The 17AML fits low to the barrel with a height of .494". The 17ATC fits rifles that use a tall vernier type rear sight. The 17ATC has a height of .852". All 17's are machined from steel and have a standard 3/8 dovetail. (Except 17AEU which has European Dovetail for Lyman Muzzleloaders).

- 17AML (Ht. .494") ..... (#3090115)
- 17ATC (Ht. .852") ..... (#3090116)
- 17AEU (Eur. Dovetail) ..... (#3171074)



17 AML, 17 ATC,  
17 AEU  
(European Dovetail)



**Turn your Muzzleloader into a Target Rifle**



**For pricing visit our website  
[www.lymanproducts.com](http://www.lymanproducts.com)**



66A



90MJT



66WB

**Lyman® 57 & 66 Receiver “Peep” Sights**

The 66 is for flat receivers, such as lever action rifles, like the Winchester 94, Marlin 336 or modern shotguns. Features include 1/4 minute audible click micrometer adjustments for elevation and windage, quick-release slide, coin-slotted “stay-set” knobs and two interchangeable aperture discs (large hunting aperture and small target aperture) for any shooting condition.

- 57WJS fits Rem 700, Win 70, Sav 110 . . . . (#3572088)
- 57SME fits Mauser, Springfield and . . . . . (#3572087)  
White Systems
- 57SMET for Mauser, Springfield and . . . . . (#3572091)  
White Systems - with target knobs
- 66A fits Win. 94 - pre. angle eject . . . . . (#3662214)
- 66LA fits Marlin 336, 1894 and 1895 . . . . . (#3662215)
- 66MC fits Marlin 39A . . . . . (#3662218)
- 66WB fits Browning & Win. 1886. . . . . (#3662265)

**90MJT Target Receiver Sight**

This sight is designed to mount on Lyman and other mounting bases available for most 22 bolt action rifles. It features audible click detente – target knobs scribed in quarter minute graduations – elevation and windage arrows. Adjustable zero scales and elevation stop screw permit instantaneous return to zero. Quick release slide allows slide to be removed with a press of the release button. Large 7/8” non-glare .040 aperture. Elevation adjustable from 1.060 to 1.560 above bore centerline.

- 90 MJT . . . . . (#3902050)
- Mounting Bases 540 for 1” receivers . . . . . (#3902085)
- Mounting Bases 640 for 15/16” receivers . . (#3902090)

**Replacement Sight Discs**

- Standard hunting disc 1/2 x .093 . . . . . (#3060960)
- Standard target disc 5/8 x .040 . . . . . (#3060964)



Shotgun Sights



**Lyman® Shotgun Sights**

Lyman Shotgun Sights are equipped with oversized ivory-like beads, which are easy to see under any light conditions and can be fitted in minutes. No. 10 Front Sights (press fit) – For use on double barrel, or ribbed single barrel guns.

- Sight only (1/2 oz.) . . . . . (#3101009)
- No. 10D Front Sights (screw fit)– For use on non-ribbed single barrel guns. These sights are supplied with a wrench.
- Sight only (1/2 oz.) . . . . . (#3101012)
- No. 11 Middle Sight (press fit) – This small middle sight is intended for use on double and ribbed single barrel guns.
- Sight only (1/2 oz.) . . . . . (#3111028)

**Note: Prices for the above sights do not include drill, tap or reamer. Drill, tap and reamer not available from Lyman. Consult local gunsmith for installation.**



**No. 16 Folding Leaf Sight**

This open rear sight with adjustable elevation blade, is the perfect auxiliary sight for scope-mounted rifles. Folds close to the barrel when not in use. Designed to fit 3/8” dovetail slots.

- Available in three models:
- 16A, 400 high, elevates to .500 . . . . . (#3161066)
  - 16B, .345 high, elevates to .445 . . . . . (#3161067)
  - 16C, .500 high, elevates to .600 . . . . . (#3161068)

**93 Match & Series 20 MJT Insert Set**

For 20 MJT-LJT, and 93 MATCH. Includes Anschutz size inserts. Two post inserts .067 – .102 wide. Five aperture inserts, .126 – .133 – .154 – .161 – .169  
Series 20 MJT: . . . . . (#3201165)



**Series 17A Insert Set**

Set includes two post-type inserts, (.050 and .100 wide), one bead insert (.062) and five aperture-type inserts, (One plastic insert with .120 hole and four steel inserts with .093, .102, .110 and .120 holes).  
Insert Set (1 oz.) . . . . . (#3171086)

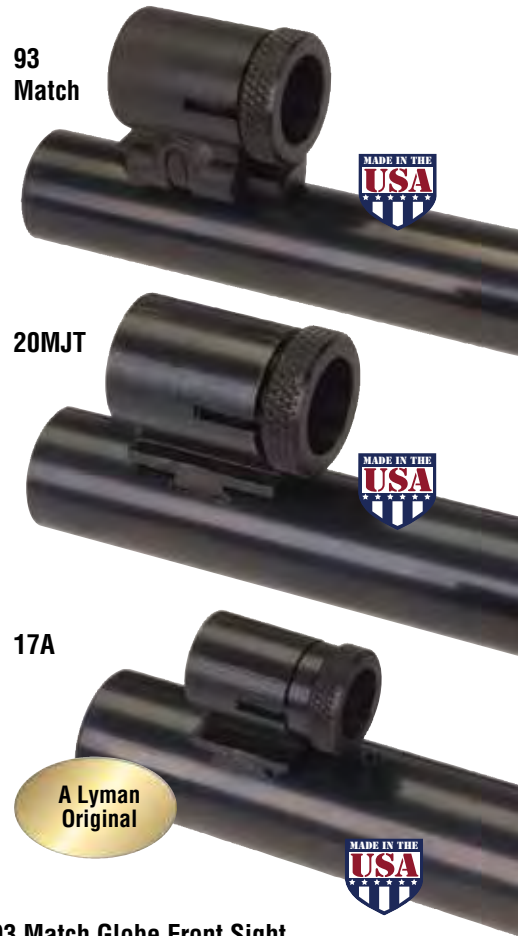
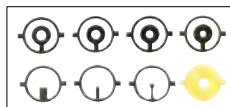

93 Match

20MJT

17A



**93 Match Globe Front Sight**

The 93 Match Globe Front Sight has been designed to fit any rifle. The 93 match sight (7/8” diameter) mounts on a standard dovetail base. It is supplied with seven Anschutz size inserts. The sight height is .550 from the top of the dovetail to the center of the aperture. Hooked locking bolt and nut provide a positive installation while allowing quick removal. Accepts most Anschutz accessories.

- Globe Front Sight (2 oz.) . . . . . (#3902035)

**20MJT Globe Front Sight**

The 20 MJT – 7/8” diameter Globe Front Sights are machined from one solid piece of steel designed to be mounted in a 3/8” barrel dovetail. 20 MJT height .700” from the bottom of dovetail to the aperture center supplied with seven Anschutz size steel apertures (see above for sizes).

- 20 MJT (3 oz.) . . . . . (#3201150)

**Series 17A Target Front Sights**

17A Target Sights are machined from a solid piece of steel and are designed to be mounted in 3/8” dovetail slots. They are supplied with eight interchangeable inserts (see photo and description) that are locked in place with a threaded cap.

- Sight Heights\*
- 17AHB .404 . . . . . (#3171076)
  - 17AMI .494 . . . . . (#3171078)
  - 17AUG .584 . . . . . (#3171080)
  - 17AEU .464 (European Dovetail) . . . . . (#3171074)

\*From bottom of dovetail to center of aperture.

**No. 12S Slot Blank**

Fills dovetail when sight is removed. (1/2 oz.) (#3121040)

**Tac-Mat™ Long Range Shooting Mats**

Lyman's Long Range Shooting Mats are perfect for long range shooting, target or tactical shooting, and varmint hunting. They offer a large footprint that will work well for even the tallest shooter, yet they roll up to a compact, easy to transport size. These comfortable mats will protect you from dirt, rocks, wet surfaces, insects, hot truck beds, gravel or pavement.

Mats will be offered in two versions, a basic design in either black or FDE; or a heavy-duty (HD) version in black. The basic model features 600D construction, with a carry handle and shoulder strap. The shoulder strap can also be used as a bipod stop. The HD version features 1000D construction, elbow pads and a built-in bipod stop, as well as a carry handle and shoulder strap.

- Tac-Mat Long Range Shooting Mat Black . . . . . (#7837850)
- Tac-Mat Long Range Shooting Mat Flat Dark Earth (FDE) . . . . . (#7837851)
- Tac-Mat HD Long Range Padded Shooting Mat Black . . . . . (#7837852)



**The Auto Advance® Remote Controlled Target Stand**



The Auto Advance Target Stand will advance your targets with the use of a hand-held remote control at distances of up to 200 yards. No more walking down-range to replace targets, or waiting for a cease-fire to be called. Advance to the next target without getting up from your shooting bench!

The Auto Advance system is battery operated, so there is no need for access to power outlets, plus it disassembles easily for transportation back and forth to the range. The Auto Advance system has protection plates that are rated for use with all rimfire calibers.

The Auto Advance system comes with a roll of standard bullseye targets. Additional 50 foot target rolls are available with bullseye, animal and silhouette designs.

- Auto Advance Target System . . . . . (#4320051)
- Bullseye Target Roll . . . . . (#4320075)
- Small Bore Target Roll . . . . . (#4320076)
- Silhouette Target Roll . . . . . (#4320077)
- Varmint Target Roll (color) . . . . . (#4320078)

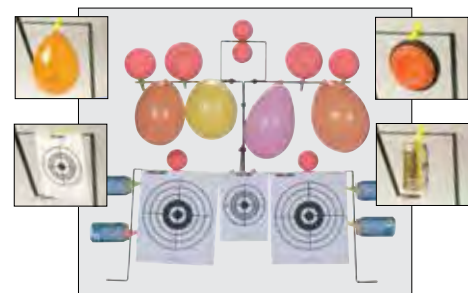

**The Original TargetMan™ Multi-Target Stand**

Lyman's Targetman target stand makes shooting more fun than ever before. This easy to use target frame is designed for any type of informal shooting with air guns, archery, slingshots and 22 Rimfire, even small caliber centerfire. It comes packed with a variety of paper targets, fluorescent target pasters, and balloons. The target stand comes with enough special mounting clips that you can mount any kind of target including clay birds or even empty cans. Its ultra strong steel construction design assembles in minutes.

Targetman . . . . . (#4320000)



**Range Kit - Pistol Starter Set**



Lyman's new Pistol Starter Set gives shooters all of the basic accessories that they need to get started in pistol shooting. The Pistol Starter Set is housed in a durable, tough 600D nylon shooter's carry bag that is a must for transporting your equipment to and from the range. Shooting bag dimensions are 15.7" X 8.85" X 10.23". Inside the bag, are all the basics that you need for eye and ear protection. The set contains quality ear protection with 25DB noise reduction, eye protection, and also a QwikDraw™ barrel cleaner for cleaning your pistol afterwards. The QwikDraw is a fast, all-in-one cleaning tool that eliminates the need for traditional cleaning rods and patches. Best of all, the total package offers a great cost savings over purchasing the items individually.

- Pistol Starter Set 380/9mm/38/357 ..... (#7837820)
- Pistol Starter Set 45/40/44cal ..... (#7837821)
- Handgun Range Bag ..... (#7837830)



**Lyman Shooting Bags**

Lyman is proud to introduce a whole line of shooting bags to help create a stable shooting platform in almost any situation. All of our Shooting Bags are made from heavy duty, abrasion resistant 600D nylon with micro-suede padding on rifle contact points. They are also equipped with a non-slip rubberized base to keep them stable and in place during use. The bags are supplied filled with a ground plastic material which holds its shape well and is light enough for easy carrying. Filling can be adjusted for optimal volume.

The Match Shooting Bag is shaped to tightly squeeze your rifle and give you a stable and secure shooting platform. The bag is equipped with a sturdy carry strap and an adjustable tensioning strap to adjust elevation. Dimensions: 8"W x 10"D x 6 1/2"H

The Wedge Shooting Bag is used to raise or lower the buttstock of your rifle to correct your aim point. Simply slide the bag forward or back to correct your elevation and aim point. Slight adjustments can be made by gently squeezing the bag. Dimensions: 4"W x 6 1/2"D x 4"H

The Crosshair Front Bag provides a stable front rest for any rifle. Dimensions: 6"W x 4 1/2"D x 7 1/2"H

The Crosshair Rear Bag features a notched design which holds the rifle stock in place. Dimensions: 5 1/2"W x 5"D x 5"H

The Crosshair Combo Set includes both the Front and Rear Bags that work perfectly together to create a customized shooting platform to meet your needs. The front and rear bags can also be clipped together for easy transportation.

**Lyman Bag Jack™**

How often do you set-up shooting rests at the range, only to find that your rifle isn't at the proper height; or the seat is too high for the bench? Lyman's Bag Jack is designed to make it easy to adjust the elevation of your rifle and bring it into line with your target, while also allowing you to maintain a comfortable shooting position. Compact, stable, and infinitely adjustable, the Bag Jack is the perfect platform to set up your shooting rest at the range. Create the optimal shooting position under any shooting conditions. The Bag Jack corrects the height with a simple turn of the adjustment knob. The lift is made from sturdy aluminum and steel components and has a non-slip textured platform. The lift is 10" x 10" so it can accommodate the largest size rests, and collapses for unmatched portability.

- Bag Jack ..... (#7837810)
- Bag Jack and Match Bag Combo ..... (#7837815)
- Wedge Range Bag ..... (#7837800)
- Match Bag ..... (#7837802)
- Crosshair Front Bag ..... (#7837803)
- Crosshair Rear Bag ..... (#7837804)
- Crosshair Combo Set ..... (#7837805)



**Pachmayr Slide Rack Assist**

The Pachmayr Slide Rack Assist is the answer for those who want extra assistance when racking the slide of semi auto handguns. Shooters with small hands, those with arthritis, and others with limited hand strength often struggle working the slide on many pistols. This innovative product fits over the slide and muzzle of your handgun, and provides a greatly increased gripping surface and significantly reduces the effort needed to rack a slide. The Slide Rack Assist is adjustable and fit most common semi-auto handguns, with the exception of CZ handguns, micro size handguns, and handguns with flared barrel muzzles greater than .660" in diameter.

- Slide Rack Assist (Black) ..... (#03890)
- Slide Rack Assist (Gray) ..... (#03892)

**WARNING:** Cancer and Reproductive Harm  
www.p65warnings.ca.gov



See them  
in action  
on YouTube!

**Flippin' Critter™ Walking Targets**

Flippin' Critters Walking Targets keeps your rimfire plinking sessions fun and interesting, while sharpening your shooting skills at the same time. Flippin' Critters have a unique "tri-pod" shape that causes the target to flip and walk away from you each time the target is hit. Each time the target flips it moves both backwards and at an angle, so you always have a new challenge for each shot. The targets are made from solid steel, so they hold up to year after year of plinking action. Available in round and prairie dog shapes and their bright color makes them easy to see.

- Flippin' Critter Prairie Dog ..... (#4321221)
- Flippin' Critter Round Target ..... (#4321220)

For pricing visit our website  
[www.lymanproducts.com](http://www.lymanproducts.com)



Lyman's Pick & Brush Set Makes a Handy Cleaning Set for Many Applications

**Gun Cleaning Solutions**

At Lyman Products, we know how important gun cleaning is, and we also know that you'd rather spend your time shooting than cleaning, so we've taken all the essential items you need and assembled them into handy kits to make gun cleaning quick and easy. Whether it's a Qwik Draw to give your firearm a speedy clean on the range, or the pistol cleaning kit to handle your handguns, or the All-in-One to cover all of your firearms, we've got you covered. We even took our years of muzzleloading experience and put together a kit just for black powder shooters.

**1 Multi Caliber Cleaning Pistol Cleaning Kit**

Covers 380 Auto, 9mm Luger, 38 Special, 357 Magnum, 40 S&W, 45 ACP and 45 Colt calibers. The handle features a rotating attachment point for the rod, which allows the rod to rotate and follow the rifling in your barrel. All the components are packed in a convenient plastic carrying case.

- 3 – bronze brushes
- 3 – mops
- 1 – cleaning rod handle
- 1 – bag of patches
- 2 – brass cleaning rods: 5 ½" rod and 2" extension
- 3 – brass jags
- 1 – slotted patch holder
- 1 – rod centering guide
- 1 – bottle of gun oil

Pistol Cleaning Kit . . . . . (#04036)

**2 Lyman's Essential All-in-One Cleaning Kit**

A compact, portable, all-in-one cleaning kit for handgun or rifle shooters. The portable, tactical style carry case is packed with all of the components needed to properly clean and protect your firearms. It features both solid brass cleaning rods as well as flexible cleaning cables, and can handle calibers from 17 up to 45. The handle has a rotating attachment point for the rods, and also a slot to attach the cables to form a "T" shaped pulling handle.

- 12 – bronze brushes
- 3 – slotted tips
- 1 – cleaning rod/cable handle
- 4 – cleaning picks/scrappers
- 1 – pack of patches
- 12 – brass jags
- 5 – brass cleaning rods
- 2 – cleaning cables
- 1 – utility brush
- 1 – gun oil

Essential Pistol & Rifle Cleaning Kit . . . . . (#04037)

**3 Lyman's Pick and Brush Set**

Allows you to clean out all those hard to reach grooves and corners that can't be reached with patches. The picks come in a variety of shapes so that you'll have just the right size to fit into those tight spots. A nylon utility brush is also included for scrubbing away tough powder residue. A "must have" for your cleaning supplies and range bags.

Pick and Brush Set . . . . . (#04038)

**4 QwikDraw™ Barrel Cleaning Rope**

The Lyman QwikDraw™ Barrel Cleaning Rope is a fast, all-in-one cleaning tool that reduces your cleaning time to a fraction of what it would be with a traditional cleaning rod. The QwikDraw™ combines a traditional bronze brush with the scrubbing action of a long bore cleaning rope to quickly clean the dirtiest bore. Simply apply some of your favorite cleaning solution to the rope, drop the weighted end of the pull cord into your chamber and let it slide out of the barrel; then pull the brush and rope through the bore for an easy, fast cleaning.

Available for: 22, 243/6mm, 270/7mm, 30, 338, 9mm/38/357, 40, 44/45, 12 ga. and 20 ga.

- QwikDraw™ .22cal . . . . . (#04060)
- QwikDraw™ .243cal . . . . . (#04061)
- QwikDraw™ .270cal/7mm . . . . . (#04062)
- QwikDraw™ .30cal . . . . . (#04063)
- QwikDraw™ .338cal . . . . . (#04064)
- QwikDraw™ 9mm/.38/.357 . . . . . (#04065)
- QwikDraw™ .40cal . . . . . (#04066)
- QwikDraw™ .44/45cal . . . . . (#04067)
- QwikDraw™ 12 Gauge . . . . . (#04068)
- QwikDraw™ 20 gauge . . . . . (#04069)

**Electronic Digital Trigger Pull Gauge**

Lyman's revolutionary Digital Trigger Pull Gauge is designed to be the fastest and most accurate trigger pull gauge available. The state-of-the-art strain gauge technology allows for accuracy of 1/10 ounce/2 grams. The gauge will read to a maximum 12lb/5.4kg and features a large, easy-to-read LCD display. To operate, simply press the ready button, hook the roller around the trigger of your firearm and pull until the trigger releases. (Make sure firearm is not loaded.) The gauge will display and hold the exact trigger pull weight. For a new reading, just press the ready button and repeat. The gauge will also give you an average of up to the last 10 readings. Switch from ounces to grams with the push of a button. The fully adjustable rod works on any firearm. This is the perfect tool for target shooters, silhouette shooters, gunsmiths, hunters, or anyone who wants to adjust their trigger pull weight accurately and easily. Works with single 9V battery (not included).

- Fully Adjustable Trigger Pull Rod allows use with all firearms
- Accurate up to 1/10 ounce/ 2 grams
- Ergonomic Design
- Roller "Self-Centers" on Face of Trigger
- Memory for Averaging up to 10 pulls
- Easy to read LCD Display reads in (pounds/ounces) or Metric (kilograms/grams)
- Ensures safe and accurate trigger adjustments

Electronic Digital Trigger Pull Gauge . . . (#7832248)



Specifications:  
 Measuring Range:  
 1oz - 12lbs / 2.8g - 5.4kg  
 Resolution:  
 0 - 5lbs: ± .1oz  
 5 - 12lbs: ± .5oz  
 0 - 2.2kg: ± 2g  
 2.2 - 5.4kg: ± 10g



**TARG-DOT**

**Stick-On Dots**

Lyman has you covered - literally! Use our stick-on Targ-Dots to make your paper targets last all day. Available in every variety to meet your shooting needs.

**Targ-Dots®**

- 1/2" 110/pk . . . (#4026050)
- 1" 100/pk . . . . (#4026100)
- 1 1/2" 70/pk . . . (#4026150)
- 2" 45/pk . . . . . (#4026200)
- 3" 25/pk . . . . . (#4026300)
- 6" 15/pk . . . . . (#4026600)



**Pasters**

- 1" Square White . . . (#4026850)
- 1" Square Black . . . (#4026800)
- 1" Round Black . . . (#4026860) (200p/pack)

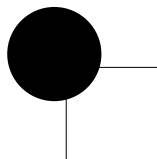

**Hot Bullseyes**

3" 25/pk . . . . . (#4026950)

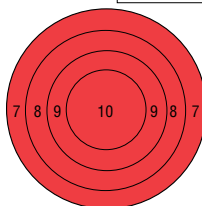

**Accupoint Dots**

- 1" 100pk . . . . . (#4026760)
- 2" 45 pk . . . . . (#4026770)
- 3" 25 pk . . . . . (#4026780)



**Animal Targets**

- Fluorescent
- 6" Turkey 10/pk . . (#4026650)
- 3" Prairie Dog 25/pk . (#4026790)



**Reloader's Labels**

- Fluorescent Green
- 1" x 2" 75/pk . . . . (#4026700)
- 2" x 2 1/2" 40/pk . . (#4026750)

Date	_____
Cartridge	_____
Case	_____
Primer	_____
Powder	_____ Wt. _____
Bullet	_____
Sights	E. _____ W. _____
Remarks	_____



**Match Assortment Sheets**

Each 7" x 10" sheet features an assortment of fluorescent cross hair and sighting targets. Includes special match target for use at ranges up to 200 yds. 10 sheets per pack. Over 200 individual target items.  
 Match Asst . . . . . (#4026880)  
 Varmint Asst . . . . . (#4026970)

**For pricing visit our website  
[www.lymanproducts.com](http://www.lymanproducts.com)**

# BORECAM™ Digital Borescope



## Borecam® Digital Borescope with Monitor

Lyman's Borescope provides active shooters with the means to carefully inspect the bores of their firearms for wear, throat erosion, tool marks, and other rifling or chamber damage, as well as for checking for fouling. The scope will fit 20 caliber and larger barrels and works with miniature camera technology. The display will show a clear image of the inside of the barrel and also allows you to take a photo of the bore. The image will be stored on a standard SD card and can later be viewed on a computer or lap top.

Borecam Digital Borescope with Monitor . . . . (#04055)



Miniature digital camera technology and bright lighting combine to provide crisp clear images.

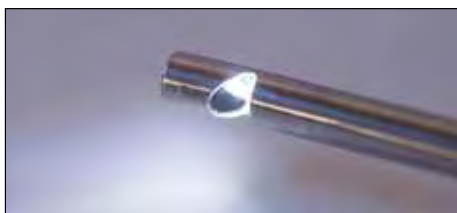

Images can be captured from the display and saved to a memory card.

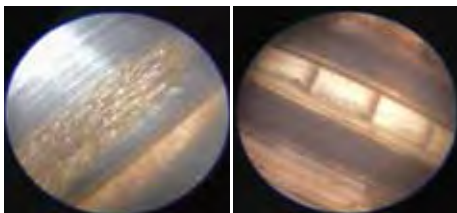

**Don't risk damage to the chamber and bore of your rifle!**

## Universal Bore Guide Set



Lyman's Universal Bore Guide Set directs and centers your cleaning rod and jag through the chamber. This protects both the chamber and the bore from abrasion by the cleaning rod during regular cleaning. "Universal" means that this set will fit most bolt actions and even includes a special adapter sleeve for the AR-15.

Precision machined from durable, anodized aluminum, the set comes with interchangeable tips that cover bore sizes from .17 up to .416 and the thread-on nozzles prevent the guide's sticking in the chamber. The guide's specially machined port makes applying solvent to the inserted cleaning patch easier and neater than trying to push a wet patch into the open end of the guide. The Universal Bore Guide Set works with most cleaning rods like Lyman's new Universal Cleaning Rod System and Jag and Brush Set.

Universal Bore Guide Set (.17 to .416). . . . . (#04045)



## Universal Cleaning Rod System

Lyman's Universal Cleaning Rod System covers all handguns and rifles with two 12" and two 36" rods that thread into the ergonomic swivel handle. Like the handle, the cleaning rods are chemical resistant. In addition, the rods are machined from spring steel and have a tough, non-abrasive proprietary epoxy coating. They are threaded to mount standard 8-32 jags and brushes like those in Lyman's 26 Piece Complete Jag and Brush Set. Rods are also available individually as listed below.

- Universal Cleaning Rod set includes Universal Handle plus 4 most popular rods:  
12" (22-26 Cal), 12" (27-45 Cal), 36" (22-26 Cal), 36" (27-45 Cal)  
Universal Cleaning Rod Set (Handle + Rods) . . (#04035)

- Cleaning Rod 27-45 CAL 12" . . . . . (#04020)
- Cleaning Rod 22-26 CAL 26" . . . . . (#04012)
- Cleaning Rod 22-26 CAL 36" . . . . . (#04014)
- Cleaning Rod 27-45 CAL 36" . . . . . (#04024)
- Cleaning Rod 17 CAL 36" . . . . . (#04030)



## 26 Piece Jag & Brush Set



Lyman's new 26 Piece Jag & Brush Set keeps your bore cleaning necessities protected and organized in a durable, hinged storage container. Containing 26 pieces organized by caliber, this set has slots for each jag and brush from .17 to .45 calibers. The hinged covers are see-through and slots are clearly marked for quick selection. All jags and brushes use standard 8-32 thread except the .17 caliber which uses a 5-40 thread. This set is the perfect companion to Lyman's Universal Cleaning Rod System.

- 26 piece set covers all calibers .17 to .45
- Durable, hinged storage box to keep neat and organized
- Compartments are identified by caliber
- Jags & brushes use a standard 8-32 thread, except .17 cal. uses 5-40 thread  
Complete 26 piece Jag and Brush Set . . . . (#7631270)

**For pricing visit our website  
www.lymanproducts.com**





**A. The Original Butch's® Bore Shine**

Designed by well known bench rest competitor Butch Fisher, this non-abrasive chemical solvent is specifically designed to remove all forms of bore fouling including copper with an absolute minimum of effort and no damage. It will quickly remove carbon build-up, even in difficult to clean areas like the chamber throat. It also removes lead, wax and even plastic shotgun wad build up.

A significant improvement over conventional solvents, Butch's can also control the copper fouling by pushing a few patches soaked with Butch's prior to shooting. Butch's is safe to use on normal and stainless barrels. It is a true "All in One" Cleaner. Try it and you will never use anything else!

- Butch's Bore Shine 3.75 oz ..... (#02937)
- Butch's Bore Shine 8 oz ..... (#02953)
- Butch's Bore Shine 16 oz ..... (#02941)

**WARNING:** This product can expose you to chemicals including 1,2,4 Trimethylbenzene, which is known to the State of California to cause cancer and/or birth defects or other reproductive harm. For more information go to [www.p65warnings.ca.gov](http://www.p65warnings.ca.gov)

**B. Butch's® Black Powder Bore Shine - Benchrest clean for black powder guns**

Butch's New Black Powder Bore Shine was developed specifically for the Black Powder Shooter who asked for a Better, faster way to clean their Rifles. Butch's Black Powder Bore Shine comes from a special cleaning solvent used by the U.S. Military. This New Black Powder bore cleaner, like the original Bore Shine does it all. Removes Powder, Lead and Plastic Fouling faster than any other cleaner. Best of all it is odorless, non-toxic, non-flammable, biodegradable and protects against rust and corrosion. You can't find a better cleaner for black powder anywhere. Butch's Black Powder Bore Shine 8oz. .... (#02949)

**WARNING:** This product can expose you to chemicals including Methyl Pyrrolidone, which is known to the State of California to cause cancer and/or birth defects or other reproductive harm. For more information go to [www.p65warnings.ca.gov](http://www.p65warnings.ca.gov)

**C. Butch's® "Triple Twill"™ Patches**

Like Butch's bore shine, these patches offer superior performance. They hold more liquid and remove fouling faster than ordinary cotton flannel patches. A special fabric used in laboratories and cleanrooms, Triple Twill's special weave has hundreds of tiny "ridges and drop zones" which scrub and capture fouling residues far better than other patches. Butch's Triple Twill patches don't shed lint and have been specially treated for maximum absorbency.

- 1-1/8" SQ. 22-270 Cal. (Bag of 1000) ..... (#02901)
- 1-1/2" SQ. 6mm Bench Rest (Bag of 1000) ... (#02913)
- 1-3/4" SQ. 7mm - 35 Cal Rifle (Bag of 750) ... (#02904)
- 2-1/4" SQ. 35 CAL - 45 Cal Rifle (Bag of 500)
- 10mm - 45 Cal Pistol ..... (#02906)
- 2-1/2" SQ. 45-58 Cal Rifle (Bag of 375)
- .410 - 20 Ga. Shotgun ..... (#02908)
- 3" SQ. 10,12 & 16 Ga. Shotgun (Bag of 300) (#02911)

**D. Butch's® Gun Oil  
U.S. Military proven formula**

Butch's Gun Oil is an ideal bore protectant and conditioner, especially when used with Butch's solvent. It is a proprietary blend of natural oils that withstands the intense heat, friction and pressures produced in a firearm's chamber and bore. The product's rust inhibitor provides the absolute maximum in corrosion protection for both regular and stainless steel firearms.

Butch's Gun Oil 4oz ..... (#02948)

**E. The Essential Gun Maintenance Mats**

Protect your gun and your workbench. Work like a pro on your Lyman Gun Mat. The firm, yet cushioned surface is perfect for assembling and disassembling firearms (or lots of other hobbies!) for cleaning or maintenance and repair. The molded compartments contain spills and keep small parts out of the way of the main work area but still handy and organized. The mats are chemical resistant and clean easily with soap and water. Handgun mat measures 15.75" x 10". Rifle Mat measures 10" x 36".

- Chemical Resistant
  - Made from synthetic rubber for a non-slip surface
  - Protects your gun's finish and your bench's finish
  - Molded-in storage compartments keep parts secured & organized
- Essential Gun Mat ..... (#04050)  
Essential Rifle Mat ..... (#04051)



**45pc. & 68pc. Lyman Master Gunsmith Tool Kits**

Pachmayr's screwdriver sets provide all the bits needed by gunsmiths and all those who work on firearms. These complete sets come with bits for slotted screws, hex screws, 6-lobe screws, and Phillips screws; in addition to an assortment of specialty bits. The specialty bits include a Weaver scope ring bit, Glock front sight bit, 1911 grip bushing bit, as well as .062", .093" and .118" pin punches. The sets also include a ratchet wrench so the maximum torque can be applied to those tough-to-remove screws. The bits for slotted screws are hollow ground, so they properly fit screw slots and prevent cam-out which creates ugly, damaged screw slots. The sets are packed in compact, convenient storage cases.



**45 Piece Set Contains**

- 12 – hollow ground bits for slotted screws
- 15 – hex bits in standard and metric sizes
- 6 – Phillips bits, including two long bits
- 3 – 6-lobe bits
- 6 – specialty bits
- 1 – extension
- 1 – ratchet wrench
- 1 – handle



**68 Piece Set Contains**

- 32 – hollow ground bits for slotted screws
- 17 – hex bits in standard and metric sizes
- 6 – Phillips bits, including two long bits
- 4 – 6-lobe bits
- 6 – specialty bits
- 1 – extension
- 1 – ratchet wrench
- 1 – handle



- Lyman Tool Kit 45 pieces ..... (#7991360)
- Lyman Tool Kit 68 Pieces ..... (#7991361)



**For pricing visit our website  
www.lymanproducts.com**



**A. Deluxe Hammer & Punch Set** 

The perfect companion for the home gunsmith or handyman. Each set features our complete selection of quality Gunsmith Punches plus the popular Brass Tapper Hammer. This unique set comes in a custom hardwood storage case which separates each punch by size for quick access.

- Deluxe Set (3 lbs.) ..... (#7031298)
- Replacement Steel Cap ..... (#7991272)
- Replacement Nylon Cap ..... (#7991271)
- Replacement Brass Cap ..... (#7991273)

**B. Gunsmith's Punch Set** 

A good selection of properly made and correctly sized punches is no longer hard to find. Now they're available from Lyman. The Gunsmith's Punch Set offers a complete selection of quality steel punches with hardened steel punch tips including 1/16", 3/32", 1/8", 5/32", 3/16", 1/8" center punch and a brass drift punch. Deluxe Set including the interchangeable head "Brass Tapper" hammer is also available. (see above)

- Gunsmith Punch Set (12 oz.) ..... (#7031273)

**C. Lyman "Brass Tapper" Hammer** 

For gunsmithing and other delicate jobs, this hammer has three interchangeable heads including nylon, brass and steel. For delicate tapping, a knurled brass drift pin stores inside the handle.

- Brass Tapper (11 oz.) ..... (#7031290)

**D. Roll Pin Punch Set** 

Ideal tools for removing hollow, split roll pins. Special round nose design allows proper alignment of punch in roll pin to prevent damage to fine mechanisms such as trigger group parts. Roll Pin Punches come in 1/16, 3/32, 1/8, 5/32 sizes.

- Punch Set(10 oz.) ..... (#7031277)



**E. Pistol Punch Set** 

For the specialized needs of pistol work, Lyman has put together a more economical assortment of punches. This basic set utilizes the same universal handle as the Gunsmith's Set with the following punches: 1/16", 3/32", 1/8", 5/32" and brass drift punch.

- Pistol Punch Set (8 oz.) ..... (#7031271)

**X-Block Gunsmith Bench Block**

Having the right tool for the job makes any gunsmithing project so much easier! Without the right tool, you may damage fine finishes or break parts. The X-Block is the right tool for anyone driving pins out of firearms. It has all the features to get the job done smoothly and professionally. The X-Block has both a "V" slot and a rounded slot running across the face of the block to support a variety of barrels and slides. The block is made of a tough, non-marring, polymer, and edged with a softer non-slip outer overmold. The block has multiple holes to take on most any project, as well as a molded in magnet on the back side of the block to catch pins and other small parts as they drop out. Its large 5" diameter provides a stable base with plenty of support.

- Large 5" diameter
- Magnet molded into base to catch pins or small parts
- Made of tough, non-marring polymer
- "V" slot and rounded slot run across the block face to fit most every need such as pistol barrels, slides and frames
- Soft, non-slip sidewalls for improved grip

- X-Block Gunsmith Bench Block ..... (#04078)

**"Essential" Tool**

Having the right tool for the job is important, but sometimes it's also important to have a "fun" tool for the job!

Impress your friends with this 50 Caliber Bottle Opener.

Precision CNC machined from solid aluminum and hard anodized, this bottle opener is sure to turn heads at your next event.

- 50 Cal Bottle Opener (#11460)



**Don't Leave Home Without it!**



**Ultimate Gunsmith Tool Kit**



The Pachmayr Ultimate Gunsmith Tool Kit provides all the tools needed by professional gunsmiths or gun enthusiasts to perform basic gun repairs, modifications or maintenance. This all-in-one kit features Pachmayr's extra strong, fixed blade screwdrivers with their unique "Torq Grip" handles. The "Torq Grip" handles provide a solid gripping surface with three slightly raised areas that allow your thumb to exert maximum torque. The driver shafts are made from tough, durable S2 tool steel and have hollow ground, magnetized tips. In addition, the kit includes a full assortment of standard punches, roll pin punches, as well as a brass drift punch, a center punch and the Brass Tapper hammer. The Brass Tapper Hammer is equipped with interchangeable nylon, brass and steel heads to cover a full range of jobs. To complete the kit, a 277 piece screw kit is also included. The screw kit has 12 each of 23 different hard to find screws which fit many sights, scope bases, scope rings, and plug screw holes.

Kit Includes:

- Master Gunsmith Screwdrivers: 1 6-Lobe Driver and 7 Flat Blade Drivers. 8 extra strong, S2 tool steel, fixed blade screwdrivers with comfortable "Torq Grip" handles that provide maximum turning power and will not roll off of a bench.
- Roll Pin Punches: 1/16", 3/32", 1/8", 5/32" Dia.
- Standard Punches: 1/16", 3/32", 1/8", 5/32", 3/16" Diameters
- Special Punches: 1/8" Diameter Center Punch, Brass Drift Punch
- Brass Tapper Hammer with Brass, Steel, and Nylon Heads
- Master Gunsmith 277 Piece Screw Kit

Ultimate Gunsmith Tool Kit. . . . . (#03085)



**Gunsmith 31 Piece Tool Kit**

Our 31 piece gunsmith screwdriver set contains the best selection of bits for working on all firearms. Gunsmith slotted bits for action screws, hex bits to fit scope mounting screws and Phillips bits including special long Phillips bits for butt plate and recoil pad removal. A must for the serious shooter.

31 Pc Tool Kit . . . . . (#03047)



**Master Gunsmith™ 120 Pc Plug Screw Set**

Contains 12 each of 10 commonly used, but easy to lose, plug screws. These fill open mounting screw holes for most scope bases or sight base/ramps. The plug screws are offered in black oxide finish and stainless steel, as well as in a straight design for flush mounting or headed to provide a positive stop. Kit includes tweezers and thread size gauge. Slotted for screwdriver installation.

KIT CONTAINS:

- #6-40 Plug (Black Oxide)
- #6-48 Plug (Black Oxide)
- #6-48 Plug (Stainless Steel)
- #6-48 Plug Screw, headed (Black Oxide)
- #6-48 Plug Screw, headed (Stainless Steel)
- #8-40 Plug (Black Oxide)
- #8-40 Plug (Stainless Steel)
- #8-40 Plug Screw, headed (Black Oxide)
- #8-40 Plug Screw, headed (Stainless Steel)
- #10-32 Plug (Black Oxide)

Master Gunsmith Plug Screw Kit . . . . . (#03062)



**Master Gunsmith™ Hex Head Ring & Base Screw Kit**

Contains 10 each of 14 premium 3/32" hex style scope ring and base screws. These difficult to find screws are favored non-slip replacements for slotted screws. Packaged in a handy storage box with individual compartments for each size screw. Includes tweezers and a thread size gauge, which also doubles as a shortening jig used to grind a screw to a shorter length. (Hex Size: 3/32)

KIT CONTAINS:

- #6-40 Fillister Head (3/8, 1/2)
- #6-40 Oval Head (1/4, 3/8)
- #6-48 Fillister Head (1/4, 3/8, 9/16)
- #6-48 Oval Head (1/4, 3/8)
- #8-40 Fillister Head (1/4, 3/8, 1/2)
- #8-40 Oval Head (1/4, 1/2)

Master Gunsmith Hex Head Screw Kit . . . . (#03058)



**Master Gunsmith™  
277 Piece Slotted Screw Kit**

The ideal companion to the Master Gunsmith Screw Driver Set. This 277 piece kit is for the firearms owner and gunsmith. This set contains 12 each of 23 different "hard to find" screws that fit common applications in many guns. Screws are contained in handy storage kit and includes tweezers.

No gun owner should be without this kit.

**KIT CONTAINS:**

- #6-48 Fillister Head (7 different lengths)
- #6-48 Oval Head (7 different lengths)
- #8-40 Fillister head (3 different lengths)
- #8-40 Oval head (3 different lengths)
- #6-40 Plug Screws
- #8-48 Plug Screws
- #10-32 Plug Screws

Master Gunsmith Slotted Screw Kit . . . . . (#03054)



**Master Gunsmith™  
6-Lobe Ring & Base Screw Kit**

Contains 10 each of 20 premium 6L-10 and 6L-15 style scope ring and base screws. These difficult to find screws are favored for their non-slip design. Packaged in a handy storage box with individual compartments for each size screw. Kit includes tweezers and a thread size gauge, which also doubles as a shortening jig used to grind a screw to a shortly length.

**KIT CONTAINS:**

- #6-40 Fillister Head T-10 (3/8, 1/2)
- #6-40 Oval Head T-10 (1/4, 3/8)
- #6-48 Fillister Head T-10 (1/4, 3/8, 9/16)
- #6-48 Oval Head T-10 (1/4, 3/8)
- #8-40 Fillister Head T-10 (1/4, 3/8, 1/2)
- #8-40 Oval Head T-10 (1/4, 1/2)
- #8-40 Fillister Head T-15 (1/4, 3/8, 1/2)
- #8-40 Oval Head T-15 (1/4, 3/8, 1/2)

Master Gunsmith 6-Lobe Screw Kit . . . . . (#03061)

# Pac-Mag™ Gun Storage Magnet



Rated for up to 30 pounds



Versatile gun storage solution



Use under a desk, night stand, counter top, or dashboard; against a wall or inside a safe



Low profile for easy concealment

**Pac-Mag™ Gun Storage Magnet**

- 3 Magnet design gives the Pac-Mag more strength than any other gun magnet on the market
- Secure almost any gun – pistol, rifle or shotgun – practically anywhere!
- Holds rifles or shotguns, in addition to handguns
- Overmolded non-marring rubber protects your gun
- Includes mounting screws, drywall anchors, and double-sided adhesive tape

PacMag Gun Storage Magnet . . . . . (#03190)

**For pricing visit our website  
www.lymanproducts.com**

## RP200 Rifle

The RP200 offers an economic design in a quick mounting shape and medium face texture. It also offers additional protection for the stock.



- *Excellent for .22LR's and varmint rifles*
- *Medium face texture*



.50"



Stippled

RP200

### RP200 Pad Specifications

Color: Black or Brown  
White Line® & Black base  
Size: Medium

PART NO.	COLOR	BASE	SIZE	FACE SHAPE	FACE TEXTURE	LENGTH * (A)	WIDTH * (B)	INSERT WIDTH (F)	PAD THICKNESS (E)
00402	Brown	White Line®	Medium	Field	Stipple	5.40"	1.85"	No Insert	.50"
00401	Black	White Line®	Medium	Field	Stipple	5.40"	1.85"	No Insert	.50"
00406	Brown	Black	Medium	Field	Stipple	5.40"	1.85"	No Insert	.50"
00408	Black	Black	Medium	Field	Stipple	5.40"	1.85"	No Insert	.50"



## RP250 Rifle

The RP250 offers ribbed face texture for secure, non-slip mounting. This economical design also protects the stock.



- *Excellent for .22's and varmint rifles*
- *Heavy face texture for non-slip*



.50"



Grooved

RP250

### RP250 Pad Specifications

Color: Black only  
Blackbase only  
Size: Medium

PART NO.	COLOR	BASE	SIZE	FACE SHAPE	FACE TEXTURE	LENGTH * (A)	WIDTH * (B)	INSERT WIDTH (F)	PAD THICKNESS (E)
00404	Black	Black	Medium	Field	Grooved	5.40"	1.85"	No Insert	.50"



## F250 Lightweight Shotgun & Rifle

The F250 is a thinner version of our Deluxe F325 pad with the same excellent qualities. The pad is an ideal choice where recoil is moderate to light.



- *Excellent for shotgun or rifle shooting*
- *Line checked for non-slip*
- *Field style*



.850"



Line Checked

F250

### F250 Pad Specifications

Colors: Black and Brown  
F250 White Line®  
Sizes: Small, Medium, and Large

PART NO.	COLOR	BASE	SIZE	FACE SHAPE	FACE TEXTURE	LENGTH * (A)	WIDTH * (B)	INSERT WIDTH (F)	PAD THICKNESS (E)
00208	Brown	White Line®	Small	Field	Lined	5.10"	1.75"	No Insert	.85"
00205	Brown	White Line®	Medium	Field	Lined	5.35"	1.80"	No Insert	.85"
00202	Brown	White Line®	Large	Field	Lined	5.35"	1.90"	No Insert	.85"
00207	Black	White Line®	Small	Field	Lined	5.10"	1.75"	No Insert	.85"
00204	Black	White Line®	Medium	Field	Lined	5.35"	1.80"	No Insert	.85"
00201	Black	White Line®	Large	Field	Lined	5.35"	1.90"	No Insert	.85"



**WARNING:** This product can expose you to chemicals including Ethylene Thiourea, which is known to the State of California to cause cancer and/or birth defects or other reproductive harm. For more information go to [www.p65warnings.ca.gov](http://www.p65warnings.ca.gov)

## 500B Presentation Rifle

The 500B is a popular replacement for a hard plastic or metal buttplate. This good looking design offers quick mounting and a reliable non-slip face texture.



### 500B Pad Specifications

Colors: Black or Brown

Black base only

Sizes: Medium (Black or Brown)

Small and Large (Black only)



- *Basketweave face for good looks and non-slip*
- *Field style face for quick mounting*

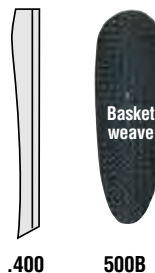

PART NO.	COLOR	BASE	SIZE	FACE SHAPE	FACE TEXTURE	LENGTH * (A)	WIDTH * (B)	INSERT WIDTH (F)	PAD THICKNESS (E)
00705	Brown	Black	Medium	Field	Bskt Weave	5.50"	1.80"	1.450"	.40"
00707	Black	Black	Small	Field	Bskt Weave	5.30"	1.68"	1.325"	.40"
00704	Black	Black	Medium	Field	Bskt Weave	5.50"	1.80"	1.450"	.40"
00701	Black	Black	Large	Field	Bskt Weave	5.75"	1.92"	1.575"	.40"

## S325 Deluxe Upland Shotgun

The S325 Deluxe pads offer the same classic appearance and excellent recoil absorbing qualities of F325 but with a faster mounting upland or Skeet shape.



### S325 Pad Specifications

Color: Black or Brown

White Line®

Sizes: Medium



- *Premium pad for Shotguns*
- *Excellent for Skeet & Upland Shooting*
- *Unique face allows a fast mount while controlling side movement*



PART NO.	COLOR	BASE	SIZE	FACE SHAPE	FACE TEXTURE	LENGTH * (A)	WIDTH * (B)	INSERT WIDTH (F)	PAD THICKNESS (E)
00107	Brown	White Line®	Medium	Skeet	Ribbed	5.40"	1.90"	No Insert	1.10"
00106	Black	White Line®	Medium	Skeet	Ribbed	5.40"	1.90"	No Insert	1.10"

## F325 Deluxe Shotgun & Rifle

The F325 Deluxe pads are popular because of their classic appearance and excellent recoil absorbing qualities. These pads are an excellent choice for those who prefer a softer side to the pad for collar bone comfort.



### F325 Pad Specifications

Color: Black or Brown

White Line® or Black base

Sizes: Small, Medium and Large



- *Premium Field Pad for Shotgun or Rifle*
- *Stippled face for non-slip*
- *Field style face for quick mounting*

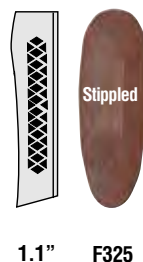

PART NO.	COLOR	BASE	SIZE	FACE SHAPE	FACE TEXTURE	LENGTH * (A)	WIDTH * (B)	INSERT WIDTH (F)	PAD THICKNESS (E)
00011	Brown	White Line®	Small	Field	Stipple	5.15"	1.80"	No Insert	1.00"
00007	Brown	White Line®	Medium	Field	Stipple	5.40"	1.95"	No Insert	1.10"
00002	Brown	White Line®	Large	Field	Stipple	5.70"	2.05"	No Insert	1.15"
00010	Black	White Line®	Small	Field	Stipple	5.15"	1.80"	No Insert	1.00"
00006	Black	White Line®	Medium	Field	Stipple	5.40"	1.95"	No Insert	1.10"
00001	Black	White Line®	Large	Field	Stipple	5.70"	2.05"	No Insert	1.15"
00310	Brown	Black	Small	Field	Stipple	5.15"	1.80"	No Insert	1.00"
00311	Brown	Black	Medium	Field	Stipple	5.40"	1.95"	No Insert	1.10"
00313	Black	Black	Small	Field	Stipple	5.15"	1.80"	No Insert	1.00"
00314	Black	Black	Medium	Field	Stipple	5.40"	1.95"	No Insert	1.10"
00315	Black	Black	Large	Field	Stipple	5.70"	2.05"	No Insert	1.15"

**WARNING:** This product can expose you to chemicals including Ethylene Thiourea, which is known to the State of California to cause cancer and/or birth defects or other reproductive harm. For more information go to [www.p65warnings.ca.gov](http://www.p65warnings.ca.gov)

For pricing visit our website  
[www.lymanproducts.com](http://www.lymanproducts.com)

## D752B Decelerator® Old English

The D752B Decelerator® Old English pad delivers dramatic recoil reduction of the Decelerator® material with the popular Old English classic shape.



### D752B Pad Specifications

Color: Black, Brown, Red  
 Black base only  
 Sizes: Small, Medium, Large, XL and Youth



- **Best selling Decelerator®**
- **“Old English Style Pad”**
- **Unique Pachmayr rounded edge design**
- **Recommended for Upland, Skeet, Sporting Clays and Rifle Shooting**

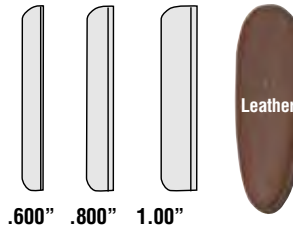

Available in three thickness shown

PART NO.	COLOR	BASE	SIZE	FACE SHAPE	FACE TEXTURE	LENGTH * (A)	WIDTH * (B)	INSERT WIDTH (F)	PAD THICKNESS (E)
01415	Black	Black	Small	Skeet	Leather	5.30"	1.68"	1.325"	.60"
01409	Black	Black	Medium	Skeet	Leather	5.50"	1.80"	1.450"	.60"
01403	Black	Black	Large	Skeet	Leather	5.75"	1.92"	1.575"	.60"
01417	Black	Black	Small	Skeet	Leather	5.30"	1.68"	1.325"	.80"
01412	Black	Black	Medium	Skeet	Leather	5.50"	1.80"	1.450"	.80"
01405	Black	Black	Large	Skeet	Leather	5.75"	1.92"	1.575"	.80"
01413	Black	Black	Small	Skeet	Leather	5.30"	1.68"	1.325"	1.00"
01407	Black	Black	Medium	Skeet	Leather	5.50"	1.80"	1.450"	1.00"
01401	Black	Black	Large	Skeet	Leather	5.75"	1.92"	1.575"	1.00"
<b>01423</b>	<b>Red</b>	<b>Black</b>	<b>Medium</b>	<b>Skeet</b>	<b>Leather</b>	<b>5.50"</b>	<b>1.80"</b>	<b>1.450"</b>	<b>1.00"</b>
01410	Brown	Black	Medium	Skeet	Leather	5.50"	1.80"	1.450"	.60"
01411	Brown	Black	Medium	Skeet	Leather	5.50"	1.80"	1.450"	.80"
01414	Brown	Black	Small	Skeet	Leather	5.30"	1.68"	1.325"	1.00"
01408	Brown	Black	Medium	Skeet	Leather	5.50"	1.80"	1.450"	1.00"
01402	Brown	Black	Large	Skeet	Leather	5.75"	1.92"	1.575"	1.00"
01380	Black	Black	Youth	Skeet	Leather	5.30"	1.68"	No Insert	1.00"



RED PADS

## 752B Old English

The Old English line remains immensely popular among Shotgunners due to its classic appearance and excellent recoil absorbing qualities. Rounded edges and Skeet style face provide quick, snag free mounting.



### 752B Pad Specifications

Colors: Black and Brown  
 Black base only  
 Sizes: Small, Medium, and Large

- **Fast mount, Classic design**
- **Skeet or Upland Shooting**

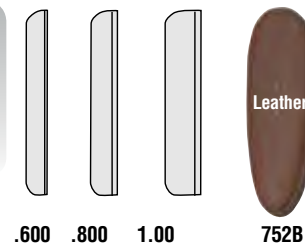

PART NO.	COLOR	BASE	SIZE	FACE SHAPE	FACE TEXTURE	LENGTH * (A)	WIDTH * (B)	INSERT WIDTH (F)	PAD THICKNESS (E)
01619	Brown	Black	Medium	Skeet	Leather	5.50"	1.80"	1.450"	.80"
01625*	Black	Black	Small	Skeet	Leather	5.30"	1.68"	1.325"	.60"
01615	Black	Black	Medium	Skeet	Leather	5.50"	1.80"	1.450"	.60"
01618	Black	Black	Medium	Skeet	Leather	5.50"	1.80"	1.450"	.80"
01621	Black	Black	Small	Skeet	Leather	5.30"	1.68"	1.325"	1.00"
01612	Black	Black	Medium	Skeet	Leather	5.50"	1.80"	1.450"	1.00"
01601	Black	Black	Large	Skeet	Leather	5.75"	1.92"	1.575"	1.00"

\* OEM only



**WARNING:** This product can expose you to chemicals including Ethylene Thiourea, which is known to the State of California to cause cancer and/or birth defects or other reproductive harm. For more information go to [www.p65warnings.ca.gov](http://www.p65warnings.ca.gov)

For pricing visit our website  
[www.lymanproducts.com](http://www.lymanproducts.com)



## DP200 & DP500 “Ultra Lite” Field Pads

Pachmayr DP200 and DP500's with Decelerator® ultra soft rubber technology offer the shooter a thin fast mounting 1/2" pad that is soft shooting.



### DP200/DP500 Specifications

Color: Black only Black base only  
 Sizes: Medium only  
 (DP200 - Stipple only) (DP500 - Basketweave only)

- *Thin .500" pad mounts fast*
- *Classic field design*
- *Recommended for light to medium recoiling rifles and shotguns*



PART NO.	COLOR	BASE	SIZE	FACE SHAPE	FACE TEXTURE	LENGTH * (A)	WIDTH * (B)	INSERT WIDTH (F)	PAD THICKNESS (E)
00426	Black	Black	Medium	Field	Stipple	5.40	1.95	No Insert	.500"
00450	Black	Black	Medium	Field	Bskt Weave	5.50	1.80	No Insert	.450"

## D750B Decelerator® Field Style

The D750B Decelerator® Field Style pad delivers dramatic recoil reduction with a basketweave finish and a shape that is ideal for heavy recoiling rifles.



### D750B Pad Specifications

Color: Black  
 Black base only  
 Sizes: Small, Medium and Large

- *Premium Rifle Pad*
- *Field style face for quick mounting and positive control*
- *Non-slip basketweave texture*
- *Recommended for heavy recoiling rifles*

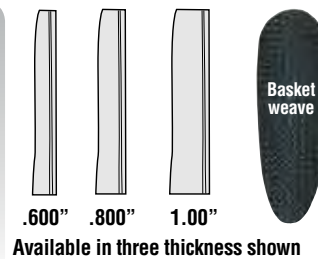

PART NO.	COLOR	BASE	SIZE	FACE SHAPE	FACE TEXTURE	LENGTH * (A)	WIDTH * (B)	INSERT WIDTH (F)	PAD THICKNESS (E)
01321	Black	Black	Medium	Field	Bskt Weave	5.50"	1.80"	1.450"	.60"
01325	Black	Black	Medium	Field	Bskt Weave	5.50"	1.80"	1.450"	.80"
01329	Black	Black	Small	Field	Bskt Weave	5.30"	1.68"	1.325"	1.00"
01317	Black	Black	Medium	Field	Bskt Weave	5.50"	1.80"	1.450"	1.00"
01305	Black	Black	Large	Field	Bskt Weave	5.75"	1.92"	1.575"	1.00"

## SC100 Decelerator® Sporting Clay

A proven, unique design makes this the fastest mounting pad available. Made with a unique hard rubber heel and our famous Decelerator® Rubber, the Unique SC100 is the ideal choice for sporting clays shooting. The SC100 is also a superior pad for upland game or target shooting.

### SC100 Pad Specifications

Color: Black, Brown or Red  
 Black base only  
 Sizes: Small, Medium, and Large



- *Unique design allows fastest mounting*
- *Old English classic good looks*
- *Decelerator® recoil absorption*

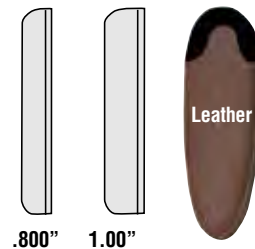

PART NO.	COLOR	BASE	SIZE	FACE SHAPE	FACE TEXTURE	LENGTH * (A)	WIDTH * (B)	INSERT WIDTH (F)	PAD THICKNESS (E)
03236	Brown	Black	Medium	Skeet	Leather	5.50"	1.80"	1.450"	1.00"
04792	Brown	Black	Medium	Skeet	Leather	5.50"	1.80"	1.450"	.80"
04856	Black	Black	Small	Skeet	Leather	5.30"	1.68"	1.325"	1.00"
03235	Black	Black	Medium	Skeet	Leather	5.50"	1.80"	1.450"	1.00"
03233	Black	Black	Large	Skeet	Leather	5.75"	1.92"	1.575"	1.00"
01912	Black	Black	Small	Skeet	Leather	5.30"	1.68"	1.325"	.80"
04793	Black	Black	Medium	Skeet	Leather	5.50"	1.80"	1.450"	.80"
01910	Black	Black	Large	Skeet	Leather	5.75"	1.92"	1.575"	.80"
04855	Red	Black	Small	Skeet	Leather	5.30"	1.68"	1.325"	1.00"
04854	Red	Black	Medium	Skeet	Leather	5.50"	1.80"	1.450"	1.00"

**NEW RED PADS AVAILABLE NOW!**

**WARNING:** This product can expose you to chemicals including Ethylene Thiourea, which is known to the State of California to cause cancer and/or birth defects or other reproductive harm. For more information go to [www.p65warnings.ca.gov](http://www.p65warnings.ca.gov)

**For pricing visit our website [www.lymanproducts.com](http://www.lymanproducts.com)**

## T550 Trap

The classic Pachmayr Trap design. Concave face and Double "X"™ sidecore design make for an attractive and comfortable pad. A favorite among competition Trap shooters.

Colors: Black  
White Line® only  
Sizes: Medium only



1.1"

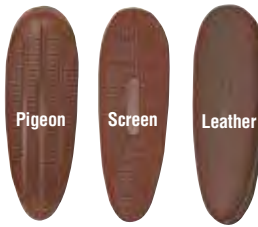

PART NO.	COLOR	BASE	SIZE	FACE SHAPE	FACE TEXTURE	LENGTH * (A)	WIDTH * (B)	INSERT WIDTH (F)	PAD THICKNESS (E)
00810	Black	White Line®	Medium	Trap	Leather	5.35"	1.95"	No Insert	1.10"
00813*	Black	White Line®	Medium	Trap	Pigeon	5.35"	1.95"	No Insert	1.10"

\* OEM only

## D550 Decelerator® Trap

Our proven Trap design combined with the famous Decelerator® material for an attractive, functional pad for all trap shooting conditions. Great for .50BMG rifles.

Color: Black  
Black base only  
Sizes: Medium and Large



1.10"



PART NO.	COLOR	BASE	SIZE	FACE SHAPE	FACE TEXTURE	LENGTH * (A)	WIDTH * (B)	INSERT WIDTH (F)	PAD THICKNESS (E)
01303	Black	Black	Medium	Trap	Pigeon	5.35	1.95	1.450	1.10"
01301	Black	Black	Large	Trap	Pigeon	5.70	2.05	1.575	1.10"

## XLT "Ultra Soft" Magnum Trap

After years of research and testing, Pachmayr engineers developed a trap pad that's almost 50% softer than the legendary Pachmayr Decelerator®. Even better, the super soft formula has the smooth grinding and installation characteristics of our popular Decelerator® pads.

Color: Black - Black base only  
Sizes: Medium & Large only



1.2"



PART NO.	COLOR	BASE	SIZE	FACE SHAPE	FACE TEXTURE	LENGTH * (A)	WIDTH * (B)	INSERT WIDTH (F)	PAD THICKNESS (E)
01640	Black	Black	Medium	Trap	Leather	5.35"	1.95"	1.45"	1.1"
01641	Black	Black	Large	Trap	Leather	5.70"	2.05"	1.57"	1.2"



## Find the Pachmayr® pad that meets your needs.

Pachmayr has a pad that will fit the needs of almost every shooter. The following suggestions will help you pinpoint your choices and find the pad for you. Template samples are available on our website to help you select the right size pad to fit your stock.

### 1. Select the Shape

What do you want the pad to do? How will you be using the rifle or shotgun? This will determine the face shape for optimum control.



#### Skeet

A convex pad design to make mounting the gun smooth without snagging. The skeet face is the best choice for wing shooting, skeet, or sporting clays.



#### Field

A combination of convex and concave shapes designed as a compromise for fast mounting and positive control.



#### Trap

A concave pad designed to provide a positive "hugging" grip on the shoulder. Specifically designed for Trap and Rifle shooting.

How much recoil absorption do you need? Pachmayr pads are available for all ranges of applications, from light to heavy recoil.

### 2. Consider the Core Design



#### Side Core

A side core design with the exposed XXXX configuration is the ultimate in recoil absorption because of the "shock absorbing" effect offered by the compressing "X" pattern. These pads have a solid base and are the best choice for those who may prefer a soft sided pad.



#### Bottom Core

A bottom core design is softer in the middle and has firmer sides to absorb the sharpest recoil. A classic appearance and availability in Decelerator® material makes this design the most popular and most copied Pachmayr design.

### Stock Spacers

Need to add some length to your stock? Pachmayr spacers add approximately 1/4" each. Available in black and White Line® styles. Add up to four when installing a new pad or adding between existing pad and stock. White Line® accent spacers are available in 1/16".

- Easily add length to stock
- White Line® and Black base styles
- Add up to 1" in length
- Gunsmith required

Black Spacer . . . . . (#02455)

White Spacer . . . . . (#03472)

### 3. Pick the Face Texture

How much control do you require in your shoulder? Will you be quick mounting or secure in your position for careful sighting? Face Texture will also play a role in your selection. Pachmayr offers several textures to optimize your shooting.



Leather

Ribbed

Line Checkered

Stippled

Basket weave

Grooved

Pigeon

#### Light Face Texture

Leather and ribbed faces are "light" face textures. These will maximize your speed when mounting.

#### Medium Face Texture

Line Checkered and stipple are "medium" face textures; best for use in field applications.

#### Heavy Face Texture

Basketweave and grooved are "heavy" face textures; best for precision shooting and big bore rifles. Our ultimate heavy design is pigeon, used ideally in live bird shoots and trap.

### 4. Find the Right Size Pad

Note: Pad and insert dimensions can vary for pad models.

1. It is best to measure your stock with the butt plate or old pad removed.
2. Always choose the pad size that is larger than your stock width and longer than the stock length to allow for toe angle.
3. Pads with inserts cannot be trimmed under the minimum width noted.
4. Keep in mind, it is not necessary for the pad holes to match your stock, since new holes should be drilled.
5. Complete size dimensions for each pad are printed on packaging.
6. Each pad comes with complete instructions.



For pricing visit our website  
[www.lymanproducts.com](http://www.lymanproducts.com)



**Renegade® Slip-On Recoil Pads**

Comfort doesn't have to cost you an arm (or a shoulder)!! Pachmayr has been the number one source for recoil pads for many years. For 2019, we are proud to introduce a new line of slip-on pads that offers excellent recoil absorption, a clean modern appearance, and 1" of additional length of pull, all at a great price. The pads will be offered in black and brown, and be available in small, medium and large sizes. Comfort and performance doesn't have to be expensive.

- Small Black ..... (#04420)
- Medium Black ..... (#04421)
- Large Black ..... (#04422)

- Small Brown ..... (#04423)
- Medium Brown ..... (#04424)
- Large Brown ..... (#04425)



Note: Renderings only. Please watch our website for actual images of the New Renegade Slip-On Recoil Pad!



No other slip on has the unique Pachmayr Speed-Mount insert.



**Decelerator® Slip-On Recoil Pads**

Combining the advanced recoil control of the popular Decelerator® internal design and material with Pachmayr's unique insert, this great looking slip-on recoil pad is unmatched by any other hunting pad. In addition, the pad's material and design make installation easier than ever. A Pachmayr original design, the Speed-Mount insert gives hunters and target competitors alike the benefit of smooth, snag-free mounting while delivering maximum recoil reduction.

Brown	Fits Stocks	Part #
Small	1-1/2" to 1-5/8" wide x 4-3/4" to 4-7/8" long	#04418
Medium	1-1/2" to 1-3/4" wide x 5" to 5-3/16" long	#04417
Large	1-3/4" to 1-7/8" wide x 5-3/16" to 5-7/16" long	#04416
Black	Fits Stocks	Part #
Small	1-1/2" to 1-5/8" wide x 4-3/4" to 4-7/8" long	#04414
Medium	1-1/2" to 1-3/4" wide x 5" to 5-3/16" long	#04413
Large	1-3/4" to 1-7/8" wide x 5-3/16" to 5-7/16" long	#04412

**Traditional Slip-On Pads**

Two sizes of Slip-On pads fit most stocks available. Easy to install and excellent recoil absorbing qualities make these one of our most popular products.

- Excellent recoil absorption
- Adds 3/4" to length of pull

**Traditional Slip-On Pad Internal Dimensions**

Size	Length	Width	Item #
Small	4.85"	1.50"	(#02306)
Medium	5.05"	1.58"	(#20223)

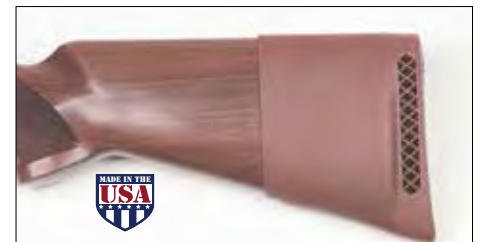

**For pricing visit our website  
www.lymanproducts.com**

# Pachmayr®



*Pachmayr has been synonymous with classic grip styling since Frank Pachmayr designed his "Presentation Grips" in the early sixties. Gripper®, Compac™, Decelerator®, and now the new Diamond Pro™ Line have always meant grips that will enhance your gun's performance as well as its looks.*

*Our Custom Series and new lines of G10 Tactical and Renegade Wood Laminate grips for pistols and revolvers continues this legacy.*

*Classic style, workmanship you can trust - Just what you expect from Pachmayr.*

### Custom Series Pearl Pistol Grips



Pachmayr's Brilliant Pearl grips add the ultimate custom look to your 1911. Our Brilliant Pearl grips replicate the appearance and feel of actual mother of pearl but at a much lower cost. Brilliant Pearl grips are strong and weather-resistant, as well as offering a smooth gripping surface which will not snag on clothing for concealed carry. Brilliant Pearl grips are available in both Black and White colors and have a recess cut for 1911's with ambidextrous safeties.

- 1911 Black Pearl Smooth ..... (#62000)
- 1911 White Pearl Smooth ..... (#62001)

### Custom Series Carbon Fiber Pistol Grips



Pachmayr's Carbon Fiber 1911 G10 grips provide the toughness and strength of carbon fiber, while also adding to the appearance of your pistol. The carbon fiber weave offers a truly unique high tech look to your 1911, while also providing a strong, weatherproof set of grips. The grips are constructed with a tough G10 base, covered with a carbon fiber weaver. The smooth outer grip surface will not snag on clothing, making them perfect for concealed carry. Pachmayr carbon fiber 1911 grips have a recess cut for models with ambidextrous safeties.

- 1911 Carbon Fiber G10 ..... (#62020)

### Custom Series Aluminum Pistol Grips



Pachmayr's Custom Series Aluminum grips are a stylish, tough and lightweight addition to your 1911 or Sig 938 pistol. The double-diamond checkering pattern adds classic good looks, while providing a non-slip grip surface. The black anodized aluminum grips are strong and impervious to weather or chemicals, and will also work on models with ambidextrous safeties.

- 1911 Aluminum Black Checkered ..... (#62050)
- Sig 938 Aluminum Black Checkered ..... (#62060)





**G10 Tactical® Pistol Grips**



G-10 material is a fiber glass based epoxy resin laminate. It is an extremely tough and durable material that is impervious to moisture, weather or chemicals, making it a perfect material for handgun grips. The multiple layered construction allows the use of different colors to be added to the grips, which create attractive patterns as it is machined. Our Pachmayr G10 Tactical pistol grips are available in two textures, our coarse Grappler pattern or checkered, and two color patterns, green/black and gray/black. Pachmayr G10 Tactical grips are the toughest, most durable and best looking grips available. Available to fit 1911's, Sig 238's and 938's, Ruger Mk III and 22/45's, Beretta 92's, and CZ 75's

G10 Tactical Pistol Grips

- 1911 Green/Black Checkered .....(#61000)
- 1911 Gray/Black Checkered .....(#61001)
- 1911 Green/Black Grappler .....(#61010)
- 1911 Gray/Black Grappler .....(#61011)
  
- P238 Green/Black Checkered .....(#61020)
- P238 Gray/Black Checkered .....(#61021)
- P238 Green/Black Grappler .....(#61030)
- P238 Gray/Black Grappler .....(#61031)
  
- P938 Green/Black Checkered .....(#61040)
- P938 Gray/Black Checkered .....(#61041)
- P938 Green/Black Grappler .....(#61050)
- P938 Gray/Black Grappler .....(#61051)
  
- Ruger Mark II/III Green/Black Checkered .....(#61060)
- Ruger Mark II/III Gray/Black Checkered .....(#61061)
- Ruger Mark II/III Green/Black Grappler .....(#61070)
- Ruger Mark II/III Gray/Black Grappler .....(#61071)

- Beretta 92 FS Green/Black Checkered .....(#61080)
- Beretta 92 FS Gray/Black Checkered .....(#61081)
- Beretta 92 FS Green/Black Grappler .....(#61090)
- Beretta 92 FS Gray/Black Grappler .....(#61091)

- CZ 75 Green/Black Checkered .....(#61100)
- CZ 75 Gray/Black Checkered .....(#61101)
- CZ 75 Green/Black Grappler .....(#61110)
- CZ 75 Gray/Black Grappler .....(#61111)

- Ruger 22/45 Green/Black Checkered .....(#61120)
- Ruger 22/45 Gray/Black Checkered .....(#61121)
- Ruger 22/45 Green/Black Grappler .....(#61130)
- Ruger 22/45 Gray/Black Grappler .....(#61131)

- CZ75 Compact G10 Green/Black Checkered ...(#61112)
- CZ75 Compact G10 Gray/Black Checkered ...(#61113)
- CZ75 Compact G10 Green/Black Grappler ...(#61114)
- CZ75 Compact G10 Gray/Black Grappler ...(#61115)

- 1911 Officer G10 Green/Black Checkered ....(#61140)
- 1911 Officer G10 Gray/Black Checkered ....(#61141)
- 1911 Officer G10 Green/Black Grappler ....(#61150)
- 1911 Officer G10 Gray/Black Grappler ....(#61151)

- Ruger MarkIV Gray/Black Checkered .....(#61076)
- Ruger MarkIV Gray/Black Grappler .....(#61075)



Beretta 92 FS #61081



1911 #61001



CZ75 Compact #61115



Ruger Mk II/III #61060



CZ 75 #61110



P238 #61030



P938 #61041



Ruger 22/45 #61131



1911 Officer #61150



Ruger MkIV #61075



**G10 Tactical® Knife**

Liner Lock Folding Knife with Black 420 High Carbon Stainless Steel Drop Point Blade, Blue G10 Handle with Safety Lock, and Heavy Duty Belt Clip.

G10 Tactical Knife . . . . . (#03095)





**Renegade™ Wood Laminate Pistol Grips** 

Pachmayr's deluxe wood laminate pistol grips are the ultimate in style and function. The wood laminate panels are highly polished and checkered, and available in two colors, Rosewood and Charcoal Silvertone. The Rosewood laminate provides classic good looks, while the Charcoal Silvertone perfectly accents stainless steel frames. The precision CNC cut checkering patterns provide a secure grip while maintaining the grip's attractive appearance. Available to fit 1911's, Ruger Mk III and 22/45's, Beretta 92's, CZ 75's and Sig 238's and 938's

- Polished wood laminate with tasteful checkering
- Available in Rosewood and Charcoal Silvertone
- Improves appearance and function
- Available for most popular semi-auto models

**Renegade Wood Laminate Pistol Grips**

- 1911 Double Diamond Rosewood . . . . .(#00440)
- 1911 Half-Checkered Rosewood . . . . .(#00445)
- 1911 Double Diamond Chk Charcoal Silvertone(#00441)
- 1911 Half Checkered Charcoal Silvertone . . . . .(#00446)

- Beretta 92 Checkered Rosewood . . . . .(#63200)
- Beretta 92 Checkered Charcoal. . . . .(#63201)

- CZ 75/85 Checkered Rosewood . . . . .(#63220)
- CZ 75/85 Checkered Charcoal . . . . .(#63221)

- Sig P238 Checkered Rosewood . . . . .(#63140)
- Sig P238 Checkered Charcoal . . . . .(#63141)

- Sig P938 Checkered Rosewood . . . . .(#63160)
- Sig P938 Checkered Charcoal . . . . .(#63161)

- Ruger Mark II/III Checkered Rosewood . . . . .(#63180)
- Ruger Mark II/III Checkered Charcoal . . . . .(#63181)

- Ruger 22/45 Checkered Rosewood . . . . .(#63240)
- Ruger 22/45 Checkered Charcoal . . . . .(#63241)

- CZ75 Compact Rosewood Checkered . . . . .(#63230)
- CZ75 Compact Charcoal Checkered . . . . .(#63231)

- 1911 Officer Rosewood Double Diamond . . . . .(#63250)
- 1911 Officer Charcoal Double Diamond . . . . .(#63251)

- Browning Hi Power Rosewood Checkered . . . . .(#63270)
- Browning Hi Power Charcoal Checkered . . . . .(#63271)

- Browning Hi Power Rosewood Smooth . . . . .(#63280)
- Browning Hi Power Charcoal Smooth . . . . .(#63281)



1911 #00446



P938 #63161



CZ Compact #63230





Beretta 92 FS #63201



CZ 75 #63220



P238 #63140



Ruger Mk II/III #63180



Ruger 22/45 #63241



1911 Officer #63251



Browning Hi Power #63271



Browning Hi Power #63280

# TACTICAL GRIP GLOVES™

These “Stretch-to-fit” Grip Gloves are custom molded for each top-selling pistol model. This makes them ideal for the popular polymer frame handguns which have no replacement grips available. In addition, Pachmayr Decelerator® material delivers proven recoil reduction and enhanced control that no other slip-on can match. They also have the right shape and flexibility to make installation “a snap” – no trimming, tearing or hard work - just a perfect fit.

Finally, the distinctive ventilated side panels and custom fit provide more instinctive gun orientation, enhanced control and they look more professional than the old, one-size-fits-all rubber band models. Tactical Grip Gloves are the only ones that “fit like a glove.”



**Tactical Grip Glove™ for Mossberg Shockwave & Remington Tac-14**

The Mossberg Shockwave and Remington Tac-14’s have become two of the most popular weapons to be introduced in recent years. Their 14” barrels and unique birds head style pistol grip makes them fast and maneuverable, however they do also pack quite a kick. With this in mind, Pachmayr now introduces a new Tactical Grip Glove, developed specifically for these firearms. This slip-on grip is easy to install and offers much better control as well as reducing recoil of the Shockwave and Tac-14. The grip features a single finger positioning groove, non-slip texturing and a thicker padded area to give the palm of your hand better protection from recoil.

Tactical Grip Glove for Moss Shockwave & Rem Tac 14 ..... (#05103)

- Ruger SR9 & SR40, Hi Point 40/45 ..... (#05158)
- \*Kahr CW9, CW40, P9, P40 ..... (#05159)
- Beretta 92 FS, M9, PX4 Storm, Hi Point 380/9mm ..... (#05160)
- Glock 42, 43, Kahr PM 9 & 40, MK 9 & 40, CM 9 & 40 ..... (#05161)
- CZ 75/85 ..... (#05162)
- Kahr P45, CW45, TP9, TP40, TP45, CT40, CT45, Sig 320 Full & Carry ..... (#05163)
- Glock 17, 20, 21, 22, 31, 34, 35, 37 ..... (#05164)
- S&W Sigma, Walther P99, Taurus 24/7 (Full Size) ..... (#05166)
- Sig 220, 226, 228, 229, Mosquito ..... (#05168)
- Springfield XD, XD(M) Full Size Frames. .... (#05170)
- S&W M&P, M&P 2.0 Full Size ..... (#05172)
- \*S&W Bodyguard 380, Kahr P380. .... (#05173)
- Glock Compacts 19, 23, 25, 32, 38 ..... (#05174)
- Glock Sub Compacts 26, 27, 28, 29, 30, 33, 36, 39 ..... (#05175)
- \*Ruger LCP, Taurus TCP, Kel-Tec P-3AT & P32, Beretta Nano ..... (#05176)
- \*Ruger LC9, LC380, SR9C, Sig P320 Sub-Comp, P938, P238, Kahr PM9, PM40, MK9 & 40, CM9& 40 ..... (#05177)
- \*Springfield XD(S) ..... (#05178)
- \*S&W M&P Shield, Ruger SR22, Walther PPS, Taurus PT 740 Slim, PT 709 Slim .. (#05179)
- \*Plain front strap, no finger grooves



**For pricing visit our website  
www.lymanproducts.com**



**Model #05158 Fits:**  
Ruger SR9 & SR40



**Model #05159 Fits:**  
\*Kahr CW9, CW40,  
P9, P40



**Model #05160 Fits:**  
Beretta 92 FS, M9,  
PX4 Storm



**Model #05161 Fits:**  
Glock 42, 43, Kahr PM9,  
PM40, MK9, MK40, CM9,  
CM40



**Model #05162 Fits:**  
CZ 75/85



**Model #05163 Fits:**  
Kahr P45, CW45, TP9,  
TP40, TP45, CT40, CT45,  
Sig 320 Full & Carry



**Model #05164 Fits:**  
Glock 17, 20, 21, 22,  
31, 34, 35, 37



**Model #05166 Fits:**  
S&W Sigma, Walther P99,  
Taurus 24/7 (Full Size)



**Model #05167 Fits:**  
Sig P320 Compact



**Model #05168 Fits:**  
Sig 220, 226, 228, 229,  
Mosquito



**Model #05170 Fits:**  
Springfield XD, XD(M)  
Full Size Frames



**Model #05172 Fits:**  
S&W M&P, M&P 2.0  
Full Size



**Model #05173 Fits:**  
\*S&W Bodyguard 380  
Kahr P380



**Model #05174 Fits:**  
Glock Compacts 19, 23,  
25, 32, 38



**Model #05175 Fits:**  
Glock Sub Compacts 26, 27,  
28, 29, 30, 33, 36, 39



**Model #05176 Fits:**  
\*Ruger LCP, Taurus TCP,  
Kel-Tec P-3AT & P32,  
Beretta Nano



**Model #05177 Fits:**  
\*Ruger LC9, LC380, SR9C, Sig P938,  
P238, P320 Sub-Comp, Kahr PM9,  
PM40, MK 9 & 40, CM 9 & 40, Sig P365.  
#05166, add S&W M&P 2.0 Compact



**Model #05178 Fits:**  
\*Springfield XD(S)



**Model #05179 Fits:**  
\*S&W M&P Shield, Ruger  
SR22, Walther PPS, Taurus  
PT 740 Slim, PT 709 Slim



**Concealed Carry**

*Our concealed carry models feature custom left and right handed palm swells to make the gun fit your hand perfectly.*

\*Plain front strap,  
no finger grooves

**For pricing visit our website  
[www.lymanproducts.com](http://www.lymanproducts.com)**

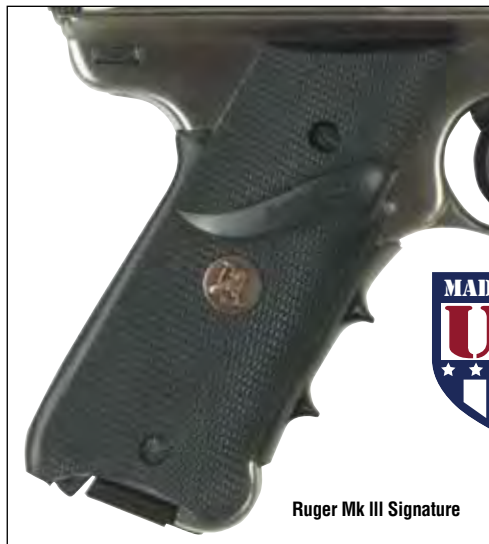

Ruger Mk III Signature



Kimber Ultra Carry II  
Uses Co-45 Grip

**Signature™ Grips With Backstraps** 

Pachmayr Signature Grips feature our unique full wrap-around design and are made from rubber specially formulated for use on semi-automatic pistols. This rubber compound gives them a feel that is unmistakably Pachmayr. Built-in steel inserts ensure they maintain their shape. Signature Grips are the overwhelming choice of competitive shooters and law enforcement personnel alike. Available in the widest variety of models for most of the popular semi-automatic pistols. Each is designed for a specific pistol and its anticipated use. (See chart below.)

**Signature™ Grips Without Backstraps** 

These models of Pachmayr Signature Grips also feature our unique full wrap-around design, are also made from rubber specially formulated for use on semi-automatic pistols, but are supplied without backstraps so they can be used on pistols such as the Government .45 models that utilize grip safety mechanisms. They are offered in the same styles as the Pachmayr Full Signature Grips; Checkered, Thumb Reduction Combat, Sculptured Thumb Reduction Combat and Combat Plus finger groove. (See Chart below.)

Gun Mfr.	Description	Standard	Combat Gripper™
Beretta	84, D/A 380	B84 02485	
	B92FS/D/G, 96FS/D/G		B92FS-G* 02500
Browning	9mm Hi-Power & Adj. Sight Version		B-HPCG* 03952
	Military Hi-power Mk III	B-HP 02420	
	.380 ACP BDA	BDA380 02437	
Colt	1911, 1911A1 & copies, Gold Cup	GM-45/C 02921**	
	Mk IV, Series 80, Delta Elite (See photos below)	GM-45 02919	GM-G* 05008
	Officer's Model	CO-45 02545	
Ruger	Mk III & Mk II	MkIII 03482	
S & W	39, 439, 539, 639 (1st & 2nd Gen.)	SW-39 03306	
	New Generation Walther PPKS (Does not fit 22 Long Rifle PPK/S Model)	PPKS 03478	
Taurus	PT-92, PT-99, 100DC, 101DC (Decocker models)		PT-99D/G* 05043

\*Model with Finger Groove \*\*Combat Version

**Colt 1911 Signature™ Grips Without Backstraps**



**1911 GM-45/C** 

Signature™ Checkered Combat This grip has a flat side panel design and a checkered front strap.



**1911 GM-45** 

Signature™ Checkered with Thumb Swell This grip has raised front swells and a checkered front strap.



**1911 GM-G** 

Signature™ Combat Plus Finger Groove This grip has increased magazine release clearance, finger groove front strap, and will work on pistols with ambidextrous safeties.

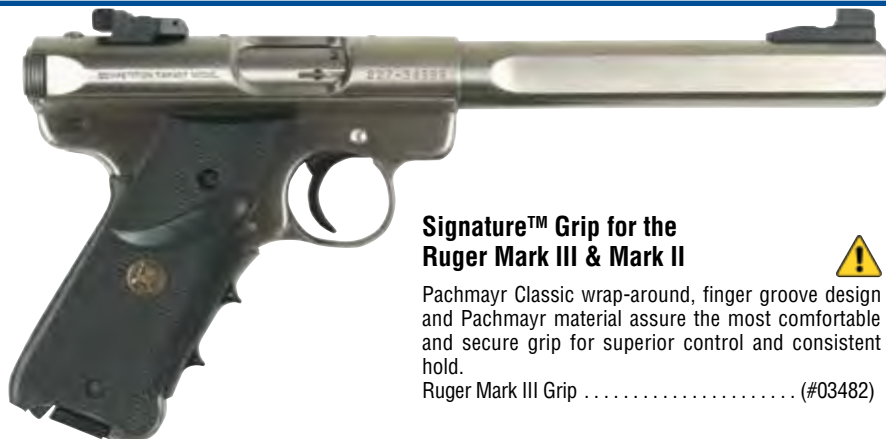

**Signature™ Grip for the Ruger Mark III & Mark II** 

Pachmayr Classic wrap-around, finger groove design and Pachmayr material assure the most comfortable and secure grip for superior control and consistent hold.

Ruger Mark III Grip ..... (#03482)

**For pricing visit our website  
www.lymanproducts.com**

 **WARNING:** Cancer and Reproductive Harm  
www.p65warnings.ca.gov



**American Legend™ Grip Models for 1911** 

With proven recoil absorbing rubber panels, comfortable finger grooves and attractive wood trim, Pachmayr's popular American Legend Grips now offer a range of eye-catching colors. Choose Rosewood, Charcoal Silvertone, or Heritage Walnut laminate or be bold with Tropical Purple or Evergreen Camo. All feature the popular American Legend wraparound design with relief cuts for ambidextrous safeties and mainspring housing pin cut-out. Whether for blued, stainless or any finish, these new American Legend Grips will enhance both the looks and handling of 1911.

- 1911 Rosewood Laminate ..... (#00423)
- 1911 "Charcoal Silvertone" Laminate ..... (#00433)
- 1911 "Heritage Walnut" Laminate ..... (#00434)
- 1911 "Tropical Purple" Laminate ..... (#00430)
- 1911 "Passionwood" Laminate ..... (#00431)
- 1911 "Evergreen Camo" Laminate ..... (#00432)

*America's most trusted name in recoil reduction, firearms tools and accessories.*

*The classic combination of form and function - Pachmayr's American Legend grips combine the look of beautiful wood grain panels with the feel of soft, sturdy rubber to ensure a solid grip.*

*Classic - Just what you expect from Pachmayr®.*



**American Legend™ Grip Series for S&W Revolvers** 

By popular demand, Pachmayr brings back – and improves – their American Legend Grips for Smith & Wesson "J", "K & L" and "N" Frame Round Butt models. The grips have updated and improved contours to evenly distribute and disperse recoil by better filling the hand.

The wraparound rubber panels that are the hallmark of these classic grips fit the wood panels with tighter tolerances than earlier designs. In addition, the grips are now offered in both traditional Rosewood and new Charcoal laminates for great looks on either blued or stainless models.

- S&W "J" Frame - Rosewood ..... (#00455)
  - S&W "J" Frame - Charcoal Silvertone ..... (#00456)
  - S&W "K&L" Frame - Rosewood ..... (#00460)
  - S&W "K&L" Frame - Charcoal Silvertone ..... (#00461)
  - S&W "N" Frame - Rosewood ..... (#00465)
  - S&W "N" Frame - Charcoal Silvertone ..... (#00466)
- Fits Round Butt Frames.



 **WARNING:** Cancer and Reproductive Harm  
www.p65warnings.ca.gov

**For pricing visit our website**  
[www.lymanproducts.com](http://www.lymanproducts.com)

**Gripper Universal Slip-On**



**Gripper™ Slip-On Grip**

Pachmayr's Gripper Slip-On Grip has a unique design and contour, allowing it to fit a large variety of popular medium to full size pistols. The Gripper Slip-On features an attractive non-slip texture along with palm swells for great fit and control. Molded in trim lines also allow you to custom fit the grip to your pistol. Perfect for Glock and other polymer frame pistols.

- Optimal size to fit a large variety of pistols.
- Gripper Slip-On Grip can be trimmed for a customized fit and feature molded trim lines to provide a clean, even cut.
- Comfortable finger grooves offer increased control.
- Backside of finger grooves are recessed to allow use on pistols with or without finger grooves, perfect for all generations of Glock's.
- Non-slip texture and palm swells for great fit and control.
- Made from a tough rubber compound, the Gripper Slip-On is impervious to weather, sweat, oils and solvents.
- Perfect for Glock and other polymer frame pistols.

This grip will fit the following pistols (some models may require trimming):

- Glock 19, 23, 25, 32, 38
  - Glock 17, 20, 21, 22, 31, 34, 35, 37
  - S&W M&P Full Size & Compact
  - S&W M&P Full Size & Compact
  - S&W M&P M2.0 Full Size & Compact
  - S&W Sigma, SD, SD VE
  - Sig 226, 228, 229
  - Sig P320 Full Size & Compact
  - Ruger SR9, Ruger 22/45
  - Beretta 92, 96
  - CZ 75, CZ P-07
  - Walther P99
  - Hi Point 380/9mm/40/45
  - Browning Hi-Power
  - H&K USP
- Note: Not for use on pistols with grip safeties.

- Gripper Universal Slip-On Black . . . . . (# 05125)
- Gripper Universal Pistol Slip-On FDE . . . . . (# 05126)
- Gripper Universal Pistol Slip-On O.D. Green . . . . . (# 05127)



**Vindicator® Pistol Grips**

Vindicator® pistol grips for shotguns have our unique air pocket recoil chamber to reduce shock, while our checkered rubber provides a vastly better grip than hard molded synthetics. Makes recoil feel less intense. Improves accuracy on second and later shots. Installs in 15 minutes or less.

Rem 870 Presentation Grip G-870R . . . . . (#04171)



**T/C Contender Grip and Forend**



The Thompson/Center Contender is a fine hunting handgun, it also packs quite a kick. The best way to control that recoil is with a Pachmayr Rubber Grip. Our Decelerator® Gripper™ model with finger grooves provides the ultimate in recoil control. (Does not fit G2)

- TC Contender Gripper Decelerator® . . . . . (#05054)
- TC Contender Forend w/ Adapter . . . . . (#03373)
- TC Contender Adapter for Forend Only . . . . . (#03381)

**The Original Widget™**

Tool for easy assembly/disassembly of 1911's.  
Widget . . . . . (#03471)

**Slip-On Grips**

**Large Frame Semi-Autos Model 2 with Finger Grooves**

Gripper™ Large Slip-On Combat finger groove design fits standard large automatic pistols with double stack magazines. Fits all models listed plus others not shown. Grip is richly textured and has a finger groove front. #05106

- Browning:** BDM, Buckmark, Challenger II
- Colt:** 2000, Double Eagle
- CZ-75**
- EAA:** Witness (CZ-75 Copy)
- Excam:** TA-90, FIE TZ-75, Targa GT21
- Glock:** #1 fits 17, 18, 20, 21, 22, 24, 31, 34, & 35
- Glock:** #2 fits 17, 18, 20, 21, 22 & 24
- High Standard:** .22 Auto
- H & K:** P-9S
- Intratec:** TEC-9, TEC-22
- Jericho:** Baby Eagle
- Kahr:** TP Series
- Ruger:** SR Series full size
- Springfield:** P-9
- Steyr:** GB
- Tanfoglio:** TZ/75
- Taurus:** 24/7 full size



**Medium Frame Semi-Autos Model 3 with Finger Grooves**

Gripper™ Compact Slip-On Combat finger groove design fits compact automatic pistols with double stack magazines. Fits all models listed plus others not shown. For medium pistols, grip is richly textured and has a finger groove front. #05108

- American Arms:** P-98
- AMT:** ON-Duty
- Glock:** 19, 23
- H & K:** M-4, USP
- Kahr:** P Series
- Llama:** M-82, M-87
- Ruger:** P91, P93, SR compacts
- Sig:** P220, P228, P229, P226
- S&W:** Novak 10xx, 39xx, 59xx, 69xx, 45xx, 40S&Ws, Sigma Series
- Springfield:** P-9 Compact
- Star:** 30PK, M-30
- Taurus:** PT-58, PT100, 745
- Walther:** P-5, P-38, P-88



**Small Frame & Compact Semi Autos Model 4 with Finger Grooves**

Gripper™ Small Slip-On Combat finger groove design fits small compact automatic pistols with single stack magazines. Fits all models listed plus others not shown. For small pistols, grip is richly textured and has a finger groove front. #05110

- American Arms:** CX-22 DA PK22, PX22, PX25
- AMT:** .380 Auto D.A.
- Davis:** .32, .380
- Kahr:** PM9, PM Series
- Llama:** .380
- Sig:** P230
- Taurus:** PT-22, PT-25, 111, 140, 145, 24/7
- G2 compacts
- Walther:** PPK



**WARNING:** Cancer and Reproductive Harm  
www.p65warnings.ca.gov

**A Revolutionary Product  
For Concealed Carry**



**GuardianGrip**

Pachmayr's new GuardianGrip is a revolutionary and innovative design made for popular concealed carry revolvers. What makes the GuardianGrip so unique is its patented finger extension. With the simple press of a button, the spring loaded finger extension drops down out of the grip, converting a two finger compact grip into a controllable three finger grip. This is the first grip which allows the concealment of a compact grip with the shooting control of a full size grip.

- Carries like a compact, shoots like a full size grip
- Convert from a 2 finger grip to a 3 finger grip with the press of a button
- Contoured for use with Speedloaders
- Impervious to moisture, weather or chemicals
- Open backstrap design with checkered grip panels

GuardianGrip S&W J Frame ..... (#02605)  
 GuardianGrip Ruger LCR ..... (#02607)  
 GuardianGrip Taurus 85/856 .... **NEW!** ..... (#02608)



**Aluminum Competition Speedloaders**

Pachmayr's new revolver Speedloaders will set the standard for quality and performance. Unlike competitive models which are made of plastic, Pachmayr's Speedloaders are precision CNC machined from solid aluminum. The Speedloader bodies are cut in a polygon shape which produces the smallest possible outside dimensions and allows them to easily fit compact revolvers. The Speedloaders are also equipped with a rattle eliminating o-ring which contacts the cartridge bases and firmly holds the rounds in place. Cartridges are released with a simple twist of the large knurled knob. Speedloaders are available for the S&W "J" frame/Ruger LCR, as well as S&W "K" and S&W "L" frame revolvers.

- Available for .38/357 S&W "J" frame/Ruger LCR, as well as S&W "K" and S&W "L" frame revolvers (These Speedloaders will also fit other popular models. See package for details.)
- CNC machined from solid aluminum
- Polygon shape for the smallest outside dimensions
- Cartridges are held firmly with no rattle
- Simple twist knob cartridge release

Speedloader J Frame .38/357 5-Shot ..... (#02650)  
 Speedloader K Frame .38/357 6-Shot ..... (#02652)  
 Speedloader L Frame .38/357 6-Shot ..... (#02654)  
 Speedloader N Frame .44 6-Shot ..... **NEW!** ..... (#02654)



Speedloaders fit the following models:

02650: S&W J Frames, Ruger LCR, Ruger SP101, Taurus 85, Rossi 68

02652: S&W K Frames; Taurus 65, 66, 80, 82; Rossi 971, 951, 851, Colt Cobra

02654: S&W L Frames; Ruger GP100

02655: S&W N Frames, Dan Wesson; Ruger Redhawk, Super Redhawk; Colt Anaconda; Taurus .44, 444 Raging Bull



**For pricing visit our website  
[www.lymanproducts.com](http://www.lymanproducts.com)**



**G10 Tactical™ Revolver Grips**

Pachmayr's Deluxe Revolver Grips are the ultimate in style and function. Now available in new G10 designs.

G-10 material is a fiberglass-based epoxy resin laminate. It is an extremely tough and durable material that is impervious to moisture, weather or chemicals, making it a perfect material for handgun grips. The multiple layered construction allows the use of different colors to be added to the grips, which create attractive patterns as it is machined.

- J Frame G10 Gray/Black Checkered . . . . . (#61161)
- Ruger SP101 G10 Gray/Black Checkered . . . . (#61221)
- Ruger LCR G10 Gray/Black Checkered . . . . . (#61232)
- Ruger LCR G10 Red/Black Checkered . . . . . (#61242)
- Taurus 85 G10 Gray/Black Checkered . . . . . (#61252)



*G10 fiberglass-based laminate is tough and durable*

*Available in Gray/Black and Red/Black for the Ruger LCR Model*



**G10 Tactical® Knife**

Liner Lock Folding Knife with Black 420 High Carbon Stainless Steel Drop Point Blade, Blue G10 Handle with Safety Lock, and Heavy Duty Belt Clip.

- G10 Tactical Knife . . . . . (#03095)



*Improves appearance and function*

*Available for S&W J-frame, Ruger SP101 & LCR and Taurus 85*





**Renegade™ Wood Laminate Revolver Grips**



Pachmayr's Deluxe Laminate Revolver Grips are the ultimate in style and function. The highly polished wood laminate panels are offered either checkered or smooth. The Deluxe Laminate Grips are available in two colors, Rosewood and Charcoal Silvertone. The Rosewood laminate provides classic good looks, while the Charcoal Silvertone perfectly accents stainless steel frames. The precision CNC cut checkering patterns provide a secure grip while maintaining the grips attractive appearance. The smooth finish is often preferred for concealed carry. Available for Smith & Wesson round butt, "J", "K&L", and "N" frames

Renegade Wood Laminate Revolver Grips

- S&W J Frame Checkered Rosewood . . . . . (#63000)
- S&W J Frame Checkered Charcoal Silvertone . (#63001)
- S&W J Frame Smooth Rosewood . . . . . (#63010)
- S&W J Frame Smooth Charcoal Silvertone . . . (#63011)

- S&W K&L Frame Checkered Rosewood. . . . . (#63020)
- S&W K&L Frame Checkered Charcoal Silvertone (#63021)
- S&W K&L Frame Smooth Rosewood. . . . . (#63030)
- S&W K&L Frame Smooth Charcoal Silvertone. (#63031)

- S&W N Frame Checkered Rosewood . . . . . (#63040)
- S&W N Frame Checkered Charcoal Silvertone . (#63041)
- S&W N Frame Smooth Rosewood . . . . . (#63050)
- S&W N Frame Smooth Charcoal Silvertone . . . (#63051)

- Ruger SP101 Grip Rosewood Checkered . . . . (#63060)
- Ruger SP101 Grip Rosewood Smooth . . . . . (#63070)

- Taurus 85 Rosewood Checkered . . . . . (#63080)
- Taurus 85 Rosewood Smooth . . . . . (#63090)



*Polished laminate wood with tasteful checkering or smooth finish*

*Available in Rosewood and Charcoal Silvertone*



*Improves appearance and function*

*Available for S&W round butt frames, Ruger SP101 and Taurus 85*

## Presentation Grips



The first grip design developed by Frank Pachmayr. This popular grip has been the mainstay of our line since the beginning and it remains popular. Pachmayr Presentation Grips feature our unique design, classic styling, and a magnificent finish with deep checkering for control and a superb shiny finish.

## Decelerator® Grips



All guns recoil, and recoil affects your accuracy, control, and overall shooting enjoyment. For those shooters who want the most out of their shooting experience, Pachmayr offers the Decelerator® Grips — 50% softer than a regular grip. The Finger Groove Decelerator® Grip is designed to control the recoil produced by a powerful revolver. Combined with recoil absorbing air cushions along the backstrap, this grip is ideal for shooters that require the ultimate control and shooting comfort.

## Compac™ Grips



Pachmayr Compac Grips are made from a specially formulated black rubber compound and are designed to maintain concealability. Although compact in design, Compac Grips still give a shooter total control, Compac Grips provide a secure, non-slip finish. That's why they are the plainclothes officer's preferred way to a more positive grip without compromising concealability.

## Gripper™ Grips



Pachmayr Gripper Grips for revolvers are made from a specially formulated rubber compound optimized for control and recoil absorption. The finger groove style is popular for combat shooting and hunting. A slight palm swell fills the hand but is not so large as to be uncomfortable. Gripper Grips are fully checkered for appearance as well as for control. Designed for correct hand position.

## Gripper™ Professional Grips



These are smaller versions of our Gripper models. The design has an open back-strap and the overall shape has been downsized. This design makes it possible for shooters with small hands or shorter fingers to better reach the trigger and obtain the advantages of a reliable combat-style Pachmayr grip.

## Compac™ Professional Grips



These are smaller versions of our Compac models that provide an even greater degree of concealability. The design has an open back strap and the overall shape has been downsized. Like the Gripper Pro series, this design makes it possible for shooters with small hands or a shorter finger to better reach the trigger and obtain the advantages of a reliable Pachmayr grip. Available in models to fit many popular revolvers.

**Pachmayr® Grips  
are all Proudly**



GUN MFR.	DESCRIPTION	Presentation	Gripper™	Gripper™ Decelerator®	Gripper™ Professional	Compac™ & Compac™ Pro
Charter Arms	Bulldog (All Models)		CHA-G 02521			CHA/C 02523
	.22 L.R. Off Duty		CHA-G 02521			CHA/C 02523
	.22 L.R. Pathfinder (All Models)		CHA-G 02521			CHA/C 02523
	Undercover (All Models)		CHA-G 02521			CHA/C 02523
	.32 S&W Undercoverette (All Models)		CHA-G 02521			CHA/C 02523
Colt	Agent, Cobra, Det. Special, Police Pos. Special, (Older Large Frame - 1940-1971)	CD-S 02514				
	Agent, Cobra, Det. Special, Police Pos. Special, Diamond Back, (Newer Small Frame)		CD-G 02513			CD/C 02515
	Official Model Match, Python		CI-G 02528			
	Official Police, Trooper, (Pre-1970)		CI-G 02528		CI-GP 02529	
Rossi	Small Revolvers 22, 32, & 38 Spec					ROS/C 03147
Ruger	.38/.357 Magnum Police Service Six, Security Six, Service Six (Square Butt), (S/N Prefix 151 or Higher)		RS6-G 03175			
	New Model Blackhawk (not w/ Bisley Frame), Old Army	RB 03137				
	RedHawk	RHK 03140		RHK-G/D 05058		
	Super RedHawk			RSHK-G/D 05150		
	SP-101					RSP/C 03183
	New Model Super Blackhawk, (sq. trigger guard only)	RSB 03163	RSB-G 05067	RSB-G/D 05134		
	New Model Super Blackhawk Stainless (sq. trigger guard only)			RSB-G/D 05134		
New Model Super Single Six, Single Six	RB 03137					
S & W	Fits All J-Frame Models with Round Butt		SJ-G 03249			SJ-C 03252/ SJ-CP pro 03254
	Fits All J-Frame Models with Square Butt		SJ-GS 03250			SJ-CS 03255
	Fits All K & L Frame Models with Round Butt		SK-GR 03266			SK-C 03270 SK-CP pro 03272
	Fits All K & L Frame Models with Square Butt	SK-L 03267	SK-G 03264		SK-GP 03265	
	Fits All N-Frame Models with Round Butt			SN-GR/D 05148		SN-C 03297
	Fits All N-Frame Models with Square Butt		SN-G 03292	SN-G/D 05056		



**The softest, best fitting, best feeling handgun grips ever!**

Pachmayr's Diamond Pro™ Series revolver grips have taken the revolver-shooting community by storm! These "Diamond Plate" textured, one-piece grips transform popular revolvers. The soft grips replace standard factory models by easily slipping over and fully wrapping around the revolver's grip frame – with no gaps or seams.

This new line of revolver grips has set a new standard with a modern look, and the extreme comfort and control shooters have come to expect from Pachmayr.

These grips fill the hand comfortably, with a natural feel and point. The unique shape is covered with our "Diamond Plate" texture, which gives you rugged good looks and absolute control of your revolver, even under the heaviest recoil. Pachmayr's proprietary blended rubber grip compound is formulated to give you the long lasting soft feel you expect and the best in recoil reduction you deserve.

The Diamond Pro™ series offers models to fit the popular line of Ruger Revolvers, including the Ruger LCR, the SP101 and the GP100, as well as Taurus Revolvers, including the Judge, Raging Bull, Tracker and Public Defender (standard and polymer frames), and the Smith & Wesson "J", "K&L", and "N" Frame Round Butt models.

- Taurus XL Frame (#02472)  
Fits Models 444, 416 & 454 (Raging Bull)
- Taurus Compact Public Defender (#02474)
- Taurus Compact Public Defender (Polymer) (#02475)



- S&W "N" Frame Round Butt (#02480)
- S&W "K&L" Frame Round Butt (#02479)
- S&W "J" Frame Round Butt (#02478)



- Ruger GP100 (#02484)
- Ruger SP101 (#02483)
- Ruger LCR (#02482)



**For pricing visit our website  
[www.lymanproducts.com](http://www.lymanproducts.com)**

**Pachmayr® Grip Extenders**

Pachmayr's Grip Extenders will greatly increase your control and shooting comfort when added to popular compact and sub-compact handguns. The extensions perfectly match the shape and texture of the handgun, so they look like they are part of the pistol, rather than an add-on. Extenders are easy to install and are made of tough, high strength polymer that stands up to the roughest handling. In addition, the Extenders come in a pack of two for a price similar to others on the market that only contain one.

**Available models that improve comfort & control without increasing magazine capacity:**

- 03881 - Glock 26, 27, 33, 39
- 03884 - Glock 26, 27, 33, 39  
adds 1/4" additional gripping surface
- 03885 - Glock 42
- 03886 - Glock 43
- 03887 - S&W M&P Shield
- 03888 - Ruger LCP
- 03889 - Sig P320
- 03893 - S&W M&P Compact
- 03894 - Glock Full & Mid Size
- 03895 - Springfield XDS

**Available models that improve comfort & control, plus increase capacity:**

- 03880 - Glock 26, 27, 33 converts 27 and 33 to 11 rounds, 26 to 13 rounds
- 03882 - Glock 26, 27, 33, 39 converts 39 to 7 rounds, 27 and 33 to 10 rounds, 26 to 12 rounds
- 03896 - Springfield XD MOD 2, plus 2 for 9mm and a plus 1 for 40 cal.



- XL Glock 26,27,33,39 . . . . . (#03880)  
Plus Capacity (+3 9mm, +2 40cal)
- Glock 26,27,33,39 (Standard). (#03881)
- Sub-Comp. Glock 26,27,33,39 . . (#03882)  
Plus Capacity (+2 9mm, +1 40cal.)
- Glock 26,27,33,39 (XL). . . . . (#03884)
- Glock 42 . . . . . (#03885)
- Glock 43 . . . . . (#03886)
- Smith & Wesson Shield 9mm. (#03887)
- Ruger LCP. . . . . (#03888)
- Sig P320 Subcompact . . . . . (#03889)
- M&P Compact. . . . . (#03893)  
Only fits 9mm & 40 cal. not 45
- Glock Mid & Full Size . . . . . (#03894)  
17/18/19/22/23/24/25/31/32/34/35/37
- Springfield XDS. . . . . (#03895)
- Springfield XD MOD . . . . . (#03896)  
2 Plus Capacity Only fits 13-round  
Sub-Compact mags. 9mm & 40SW only  
(Not 10-round mags) Does not fit 45 cal.

**Due to increased magazine capacity, please check your state regulations before purchasing.**



03886



03882



03887



03880



03884



03881



03885



03888



03889



03893



03894



03895



03896

**For pricing visit our website  
www.lymanproducts.com**



**INCREASE THE CAPACITY OF YOUR HANDGUN USING A PACHMAYR MAG SLEEVE.**



**Pachmayr® Mag Sleeves**

Many popular compact handgun models will accept magazines used in the full size version of the same model, thus increasing your magazine capacity. These longer magazines will extend down below the grip frame however, making the grip uncomfortable and unsightly. The Pachmayr Mag Sleeve fills this void, providing an enhanced grip and making the longer magazine look like it belongs! The Mag Sleeve simply slides over the magazine and is secured with a set screw. Available for most popular compact and sub-compact handguns.

Part # . . . For Gun(s) . . . . .	Magazine
03850 . . . Glock 19/23/32 . . . . .	Glock 17/22/31 Mags
03851 . . . Glock 26/27 . . . . .	Glock 17/22 Mags
03852 . . . Glock 26/27 . . . . .	Glock 19/23 Mags
03853 . . . Glock 29/30 . . . . .	Glock 20/21 Mags
03854 . . . Sprgflid XD9/XD40 Sub Comp . . .	Springfield XD9/XD40 Mags
03855 . . . Springfield XD45 Compact . . . . .	Springfield XD45 Mags
03856 . . . S&W M&P 9C/M&P 40C . . . . .	S&W M&P 9/M&P 40 Mags
03857 . . . Kahr PM9 . . . . .	Kahr P9 Mags
03858 . . . Kahr MK9 . . . . .	Kahr K9 Mags
03859 . . . Colt 1911 Officer . . . . .	Colt 1911 Government Mags
03860 . . . Para P10 . . . . .	Para P13 Mags
03861 . . . Para P10 . . . . .	Para P14 Mags



**For pricing visit our website  
www.lymanproducts.com**



**Carbon Fiber Magazine Extensions**

TacStar® continues their position as a leader in top quality, high tech shotgun accessories with the introduction of Carbon Fiber magazine extensions. Carbon fiber offers an unbeatable strength to weight ratio. These extensions are about 4 times lighter than traditional steel tubes, however they are much stronger. The carbon fiber offers durability and toughness to go along with light weight, making it the perfect material for extension tubes. As an example, with the 10 shot extension, you save nearly a half a pound using the carbon fiber tube compared to a steel tube.

In addition, we also include a high visibility follower which is machined out of solid aluminum and is designed to improve feeding; as well as a barrel magazine clamp.

The extensions are available in 7 shot, 8 shot and 10 shot capacities. The 7 shot extension adds 2 rounds, the 8 shot adds 3 rounds and the 10 shot adds 5 rounds to your shotguns' total capacity.

Shotgun Model	Mag. Ext.	Part No
Benelli Nova, Beretta 1301	7 shot	(#1081500)
Rem 870, 100, 11-87	8 shot	(#1081501)
Rem 870, 100, 11-87	10 shot	(#1081502)
Rem 870, 100, 11-87	7 Shot	(#1081503)
Moss 930	8 shot	(#1081504)
Benelli M1/M2	8 shot	(#1081505)



**TacStar® Steel Magazine Extensions**

Machined from solid steel\*, popular TacStar Magazine Extensions are easy to install. No gunsmithing is needed and most can be removed to return the gun to the original configuration. The seven-shot extension allows for two extra rounds, the eight-shot adds three and the ten-shot adds five more rounds to the shotgun's capacity. Ten-shot extensions include a Barrel/Magazine Clamp. All extensions include a specially calibrated new spring. (\*Note: Benelli M4 tube is aluminum.)

Shotgun Model	Mag. Ext.	Part No
Benelli Nova, Super Nova, Beretta 1301	7-Shot	(#1081188)
Benelli M-4 (Incl. Hi-Vis Follower)	8-Shot	(#1081185)
Benelli M1, M2, Super Black Eagle	8-Shot	(#1081189)
Mossberg 930/935	8-Shot	(#1081201)
Rem. 870, 1100, 11-87	7-Shot	(#1081169)
Rem. 870, 1100, 11-87 Parkerized	7-Shot	(#1081184)
Rem. 870, 1100, 11-87	8-Shot	(#1081170)
Rem. 870, 1100, 11-87 Parkerized	8-Shot	(#1081186)
Remington 870	10-Shot	(#1081179)
Remington 1100/11-87	10-Shot	(#1081180)
Winchester 1200/1300 Defender & Black Shadow	7-Shot	(#1081177)
Winchester SX3, SX4	8-Shot	(#1081203)



**Carbon Fiber Technology: Light weight with Unbeatable Strength**

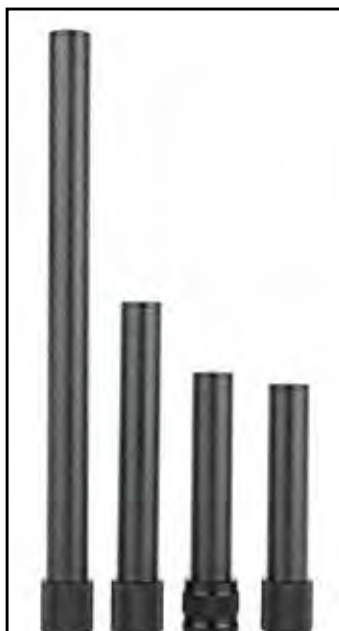

# Not Your Average "Lightweight"

**Carbon Fiber Technology:  
Light weight with  
Unbeatable Strength**



**More Strength / Less Weight**

## Carbon Fiber AR-15 Handguards with Sight Rail

TacStar's New Carbon Fiber Handguards are a rugged, highly functional addition to your AR. Carbon fiber offers an unbeatable strength to weight ratio, offering durability and toughness to go along with their light weight and good looks. Unlike Handguards made of aluminum and other materials, carbon fiber Handguards stay cool to the touch even with extensive firing. The fully free floating octagon Handguards are equipped with multiple cooling slots and accessory mounting points. The mounting points will accept any M-LOK® style mounting hardware used with accessories such as slings, bi-pods, lights or vertical grips. Additionally the Handguards are equipped with a forward mounted Picatinny rail to attach sights. The Handguard attaches to the rifle using an innovative aluminum mounting sleeve. The sleeve simply clamps over the existing barrel nut meaning no special tools are needed for installation. Handguards are available in Carbine (10"), Mid (12") and Rifle (15") lengths to cover any standard gas port location.

- Made of durable, tough and light weigh carbon fiber
- Free floating design
- Stays cool to the touch, even with extensive firing
- Multiple cooling slots and mounting points
- Accepts M-LOK® equipped mounting hardware
- Three lengths available, 10", 12" and 15"
- Equipped with Picatinny rail for sight mounting
- Easy installation. Barrel nut does not need to be removed

Carbon Fiber AR-15 Handguard 10", 7.5oz. . . . . (#1081115)  
 Carbon Fiber AR-15 Handguard 12", 8.5oz. . . . . (#1081116)  
 Carbon Fiber AR-15 Handguard 15", 9.5oz. . . . . (#1081117)



Made of durable, tough and light weigh carbon fiber



Accepts M-LOK® equipped mounting hardware



Three lengths available, 10", 12" and 15"

**For pricing visit our website  
www.lymanproducts.com**



**Shotgun Rail Mount with SideSaddle®**



Here's a simple and effective tactical upgrade for 12 gauge Remington 870, 1100 and 11-87 shotguns and now also for Mossberg 500, 590 and 930 shotguns and Benelli M2 and M4 shotguns – no gunsmith needed. Ultra-rigid, this innovative lightweight aluminum unit straddles both sides of the receiver and is crafted with a non-glare anodized finish. The top Picatinny rail can mount a variety of accessories, yet is designed to sit just high enough to allow continued use of the shotgun's bead sight. Keeping six shells in readiness, the low profile design SideSaddle incorporates TacStar's proprietary material for durability and secure shell retention.

- Remington ..... (#1081035)
- Mossberg 500, 590 ..... (#1081029)
- Benelli M2 ..... (#1081021)
- Benelli M4 ..... (#1081022)
- Mossberg 930 ..... (#1081030)



**The Original SideSaddle® Shotgun Carrier**

The unique TacStar® SideSaddle mounts extra rounds on your shotgun in a convenient and accessible location for fast reloading. The Hytrel® polymer shell carrier is attached to an aluminum mounting plate that installs directly on the shotgun receiver. All mounting screws are included, no gunsmithing required. Installation is easy, and in most cases requires no alterations to the shotgun. Note: some field grade shotguns may require a modification to the shotgun's forend. Shotguns using the TacStar pistol grip forend do not require modification. The 4-round SideSaddle will also work smoothly with all models without modification. Works great as a separate Shotgun Storage Caddy for Duck Blind, Boat or Hunting Cabin!

**REQUESTED BY LAW ENFORCEMENT**

**Exposed Serial Number 4-Round SideSaddle® for the Remington 870 & 11-87 Requested by LE Professionals.**

Armors and law enforcement agencies use serial numbers to track their firearms for maintenance, inventory and record keeping. The SideSaddle's convenient serial number port is the perfect answer.

Rem. 4-Shot Side Saddle ..... (#1081166)



**6-Shot SideSaddle®**



When combined with the TacStar® M-4 magazine extension, this 6-round delivers an awesome 13 round capacity that travels with the shotgun.



**TacStar 4-Shot SideSaddle®**



TacStar's 4 round SideSaddle Shotgun Carrier is the perfect accessory for all your hunting shotguns. It mounts easily to the side of the receiver and requires no modifications to the shotgun. Each SideSaddle is designed to provide clearance for long forends, such as the Benelli Nova model, and come with all mounting hardware. SideSaddles keep extra shells securely in place and in the perfect location for reloading. No more digging in pockets for extra shells.



**Slimline SideSaddle®**



Our SideSaddle line has gained a large following because of their convenient placement of shells right where you need them for a fast reload. We have now taken the SideSaddle to the next level with our streamlined version. We use a non-glare, anodized aluminum backing plate material and we have contoured the plate so that it takes up less space on the receiver and has fewer areas that could potentially snag. Additionally we have changed the shell carrier itself to our proprietary flexible synthetic rubber material, which offers durability and weather resistance as well as secure shell retention. Like the backing plate, the shell carrier also is smaller in size than our traditional SideSaddle, adding to its sleek appearance.

- Sleek, streamlined appearance
- Strong, rigid, non-glare, anodized aluminum backing plate
- Durable, flexible synthetic rubber shell carrier with secure shell retention
- Reduced size and streamlined shape reduce chances of snagging
- Available for Remington 870/1100/11-87 and Mossberg 500/590

Remington ..... (#1081211)  
 Mossberg 500, 590 ..... (#1081210)  
 Mossberg 930 ..... (#1081212)



**Which SideSaddle Models are available for each Shotgun Model?**

Shotgun Model	6 Shot (12ga) Item#	4 Shot (12ga) Item#	4 Shot (20ga) Item#	Slimline Item#	Rail Mount Item#
Benelli M2	—	—	—	—	1081021
Benelli M4	1081164	—	—	—	1081022
Benelli Nova	—	1081140	—	—	—
Mossberg 500, 590	1081159	1081167	1081134	1081210	1081029
Mossberg 930/935	1081158	—	—	1081212	1081030
Rem 870, 1100 & 11-87	1081157	1081168	1081130	1081211	1081035
Rem. 870 & 1187 (4-Shot Exp. Serial #)	—	1081166	—	—	—
Winchester 1200, 1300, FN TPS	1081161	—	—	—	—
Winchester SX3	1081160	—	—	—	—



**WARNING:** Cancer and Reproductive Harm  
[www.p65warnings.ca.gov](http://www.p65warnings.ca.gov)

**For pricing visit our website**  
[www.lymanproducts.com](http://www.lymanproducts.com)



*Tactical Light Pressure Switch mounts easily onto Front Grip.*



**Tactical Shotgun Grips**

TacStar® took a long, hard look at tactical shotgun grips, and then re-engineered them totally. The result is the most rugged front and rear pistol grips TacStar has ever offered. These tough, one piece, reinforced polymer models also incorporate an advanced, finger groove, ergonomic design. By better fitting both of the shooters hands, these grips enhance control, operation and recoil reduction. Made in the USA, TacStar's Tactical Shotgun Grips are easy to install – the Mossberg/Maverick model even includes integral action bars. Available for 12 ga. models only listed below: Remington 870, Mossberg 500/590/600, Maverick 88.

- Front Grip (Moss./Maverick) W/Action Bars (#1081151)
- Rear Grip (Mossberg/Maverick) . . . . . (#1081152)
- Front Grip Remington . . . . . (#1081153)
- Rear Grip Remington . . . . . (#1081154)
- Front and Rear Grip Set (Moss./Maverick) . . (#1081150)

**Weapons Light System (WLS) 2000**

- 6 Volt Tactical LED Light
- LED Technology Extends Battery Life
- Ultra Bright 750 Lumens
- Impact Bezel for Self-Defense
- Pressure Activated Tape Switch
- Recoil Shock Resistant
- 2 Clamp-on Mounts and 1 Picatinny Mount Included
- Hand held Tail Switch
- Fits most Rifles and Shotguns from 22 cal to 12 ga.
- Two (3 Volt) Lithium Batteries Included

Specifications: Length: 5.75"  
 Diameter: 1 inch Body, 1.32 inch Head  
 Weight: 5.5 ounces with batteries  
 Reflector: Coated Aluminum  
 Batteries: (2) 3 Volt Lithium  
 Battery Life: Up to 6 hours continuous  
 Construction: 6061 T6 Aluminum  
 Finish: Black Anodized  
 Weapons Light System 2000 . . . . . (#1081025)



**Tactical Shotgun Rail Mounts**

The TacStar® Shotgun Rail Mount is designed to fit standard 1" diameter magazine extensions and allows for easy mounting of tactical lights and/or lasers. The mount has three standard Picatinny rails positioned 90 degrees apart which allows for plenty of options when mounting accessories to the shotgun. The mount uses an easy to install clamping system which will not mar extensions, yet is strong and secure. Picatinny rails will accept most scope/light/laser mounting rings.

The shotgun rail mount is available in two lengths. Choose the length that best fits your extension length and accessories. Keep in mind space for a barrel/magazine clamp if used. The short mount is approximately 1.8" and the long mount is 4.1".

Note: Some semi-automatic shotguns are weight sensitive and accessories adding weight may cause short cycling with some ammunition. It is recommended that you function test the shotgun after installation.

- Tactical Shotgun Rail Mount Short . . . . . (#1081100)
- Tactical Shotgun Rail Mount Long . . . . . (#1081104)



Light shown in Rail Mount photo above is not available from Lyman Products.



**Tactical Grip Glove™ for Mossberg Shockwave & Remington Tac-14**

The Mossberg Shockwave and Remington Tac-14's have become two of the most popular weapons to be introduced in recent years. Their 14" barrels and unique birds head style pistol grip makes them fast and maneuverable, however they do also pack quite a kick. With this in mind, Pachmayr now introduces a new Tactical Grip Glove, developed specifically for these firearms. This slip-on grip is easy to install and offers much better control as well as reducing recoil of the Shockwave and Tac-14. The grip features a single finger positioning groove, non-slip texturing and a thicker padded area to give the palm of your hand better protection from recoil.

- Tactical Grip Glove for Moss Shockwave & Rem Tac 14 . . . . . (#05103)

**For pricing visit our website  
[www.lymanproducts.com](http://www.lymanproducts.com)**



**Shotgun Accessories**



**Barrel/Magazine Clamp**

Stabilizes the Magazine Extension by clamping it to the barrel. The QD Swivel attaches to the swivel base for sling attachment. (Sold Separately)

BMC-R (#1081172) M4, Nova, Rem 870, Win 1200/1300

BMC-U (#1081173) M1,M2, Rem 1100/11-87 & Moss 500/600

**Universal Barrel Mounts**

Attaches WLS 2000 light or similar to barrel. Two-piece precision machined mounts fit firearms from .22 cal. to 12 gauge. (See size listing below). Mounts clamp on securely and easily.

UBM-2 Mount for 1/2" to 3/4" barrel x 1" light (#1081112)

UBM-4 Mount for 3/4" to 1" barrel x 1" light (#1081114)



UBM

**High Visibility Follower**

The TacStar® High Visibility Follower makes it easy to confirm that a shotgun magazine is empty. Its bright orange color will be easily spotted at the load port, confirming that the magazine is empty. The shape of the follower also provides improved functioning compared to factory followers and it is machined from solid aluminum for durability.

High Visibility Follower ..... (#1081200)



**Universal Barrel Shroud**

Our Universal Barrel Shroud fits most 12 gauge pump shotguns. It is machined from all-steel with a black oxide finish. It is 13 3/4" in length and designed with a circular friction-fit bracket at the rear and a locking clamp at the front for a recoil resistant fit on the barrel.

Universal Barrel Shroud (UBS) ..... (#1081171)

**Brass Catcher with Picatinny Rail Mount**

TacStar's Brass Catcher is the perfect accessory for AR shooters who reload. No more walking around bent over trying to find where your brass flew! The Brass Catcher simply clamps to the Picatinny rail of flat top AR's. No firearm modifications are needed. The mounting bracket is adjustable and low profile, so it can be positioned to clear optics or scopes. The heat resistant catch bag can hold up to 120 .223 cases. When you are ready to empty the bag, simply pull it off of the mounting rail and dump out the shells! The bag also can be unsnapped from its aluminum deflector plate for thorough cleaning.

- Clamps to Picatinny rails on flat top AR's
- No Modifications needed
- Shell bag pulls off mount for easy emptying
- Low profile and adjustable
- Holds up to 120 .223 cases
- Heat resistant bag

Brass Catcher with Rail Mount ..... (#1081240)



**THE FULL RANGE OF TARGET ADJUSTMENTS IN ONE AR-15 STOCK**



**AR-15 AMRS Adjustable Match Rifle Stock**

TacStar's new AR-15 Adjustable Match Rifle Stock offers a full range of adjustments and features that can give any AR-15 (with A2 tube) a precisely adjustable match-grade buttstock. Both comb height and length of pull can be adjusted to provide a match-grade, custom fit for any shooter. Built with the TacStar quality that shooters rely on, the AR-15 AMRS also carries other important features like a hidden Picatinny rail for a stabilizing monopod. In addition, there are several sling mounting points including ports for push button quick release swivels (swivels not included) and fixed sling loops. The AR-15 AMRS is the easiest, most practical final upgrade for any AR.



- Comb height adjustable by .75" 
  - Adjustable butt plate adjusts length of pull by 1"
  - Hidden Picatinny rail accepts monopods
  - Push button quick release swivel ports, plus sling loops
- AR-15 AMRS ..... (#1081123)



**AR-15 Rear Grip**

Through the years, Pachmayr has listened to what our customers and MSR shooters have been looking for in an AR15 Grip. We then took this input and designed our new AR15 Grip. It has all of the features that have been asked for, including a hand-filling yet slim shape, shallow finger grooves for fast grip acquisition, and proper hand location for easy trigger reach and control. The grip has a synthetic rubber over-mold construction, along with a good looking yet non-slip texture. The grip is impervious to gun oils or solvents and will stand up to rough use.

AR Rear Grip ..... (#02466)



**AR-15 Recoil Pad**

Pachmayr's new AR15 Slip-On Pad is the answer for those looking for an easy to install, non-slip pad for their standard M4 stocks. The pad simply slips over the edges of the M4 buttstock to secure it in place. The non-slip texture keeps the rifle firmly against your shoulder, yet looks good and makes the pad appear to be part of the rifle. The pad also features an internal cushioning section to reduce recoil. Fits most M4 style stocks with butts approximately 5 1/4" long and 1 9/16" wide.

AR 15 Recoil Pad ..... (#20225)



 **WARNING:** Cancer and Reproductive Harm  
www.p65warnings.ca.gov



**TacStar® Collapsible AR Stock**

TacStar's Collapsible AR Stock is a tough, versatile, feature packed replacement stock for AR carbines. The stock is made of super strong, glass reinforced polymer and has a unique "A" frame shape to protect the length adjustment lever. Multiple sling attachment options are provided, which include QD sling attachment ports on both sides as well as a sling slot. A removable rubber butt pad comes with the stock which provides secure, non-slip mounting and reduces felt recoil. The stock offers a precise fit to mil-spec (1.146" diameter) buffer tubes for smooth length adjustment.

AR15 Collapsible Stock Mil-Spec Diameter ..... (#1081118)

**TacStar® Stock Adapters**

TacStar's Stock Adapters are designed to allow the use of any AR-15 type telescoping stocks and pistols grips on your shotgun. Unlike some competitive polymer adapters, TacStar's are made of a tough die cast metal alloy which not only provides greater strength, but also additional weight to reduce felt recoil. Designed to perfectly match the factory receiver contours and mount up seamlessly. The adapters are designed for proper drop to use bead or ghost ring sights. The adapters will accept any standard AR-15 grip without a beavertail, or one having a flexible rubber beavertail, such as Pachmayr's, Ergo's and some Hogues. The adapter also features QD sling attachment ports on both sides. Available for Mossberg 500/590 and Remington 870 shotguns. (Does not include buffer tube or stock.)  
Tactical Stock Adapter, Mossberg 500 ..... (#1081230)  
Tactical Stock Adapter, Remington 870 ..... (#1081231)



**TacStar® Collapsible Stock Kit**

TacStar's Collapsible Stock kit is a complete, versatile, feature packed collapsible stock kit designed for Mossberg 500/590 and Remington 870 shotguns. This bolt-on upgrade kit will significantly increase your firearm's ergonomics and versatility. Length of pull adjusts from 11 to 14 1/4" allowing the user to correctly fit the shotgun to their body or situation. The stock is made of super strong, glass reinforced polymer and has a unique "A" frame shape to protect the length adjustment lever. Multiple sling attachment options are provided, which include QD sling attachment ports on both sides of the stock and also on both sides of the adapter, as well as a sling slot on the stock. A removable rubber butt pad comes with the stock which provides secure, non-slip mounting and reduces felt recoil. The stock is designed for the proper drop to use bead or ghost ring sights. Unlike some competitive models, TacStar's stock adapters are made of a tough die cast metal alloy which not only provides greater strength, but also additional weight to reduce felt recoil. The package comes with Pachmayr's AR15 Grip, which features a hand-filling yet slim shape, shallow finger grooves for fast grip acquisition, and proper hand location for easy trigger reach and control. These easy to install kits are available for Mossberg 500/590 and Remington 870 shotguns.

Collapsible Shotgun Stock Kit, Mossberg 500/590 ..... (#1081220)  
Collapsible Shotgun Stock Kit, Remington 870 ..... (#1081221)



**WARNING:** Cancer and Reproductive Harm  
[www.p65warnings.ca.gov](http://www.p65warnings.ca.gov)

For pricing visit our website  
[www.lymanproducts.com](http://www.lymanproducts.com)

# New **A-ZOOM**® Blue - Value Packs



**Shotshell (5 packs)**

- 12 Gauge ..... 5/pack ..... (#12311)
- 20 Gauge ..... 5/pack ..... (#12313)

**Savings  
28%**

**Centerfire Pistol (10 packs)**

- 380 ..... 10/pack ..... (#15313)
- 9mm ..... 10/pack ..... (#15316)
- 40 S&W ..... 10/pack ..... (#15314)
- 45 ACP ..... 10/pack ..... (#15315)

**Savings  
33%**

**Revolver (12 packs)**

- 38 Special ..... 12/pack ..... (#16318)
- 357 Mag ..... 12/pack ..... (#16319)

**Savings  
33%**

**Centerfire Rifle**

- 223 ..... 10/pack ..... (#12322)
- 243 ..... 5/pack ..... (#12323)
- 270 ..... 5/pack ..... (#12324)
- 30-30 ..... 5/pack ..... (#12329)
- 308 ..... 10/pack ..... (#12327)
- 30-06 ..... 5/pack ..... (#12328)

**Up to  
60%  
Savings**



**Rugged .22 Rimfire Snap Caps  
Dry fire .22 LR Rimfire safely without  
chamber damage.**

Packed in handy 24 packs, these Pachmayr snap caps are precisely molded from a resilient polymer for many safe, damage-free hammer drops. After extensive experimentation and testing, these tough, polymer snap caps are proven to deliver long life and many hammer drops. In fact, testing has shown that these snap caps can withstand up to 5-times as many hammer drops as the other "disposable" rimfire snap caps.



- .22 Rimfire Snap Caps ..... (#03200)

**A-Zoom® 22 Rimfire Action Proving  
Training Rounds**

These .22 Rimfire dummy rounds are ideal for gun testing and shooter training. Not snap caps, but rather precisely dimensioned, functional dummies; A-Zoom Training Rounds are CNC machined from solid aluminum and hard anodized. A-Zoom .22 Rimfire dummies are widely used for hunter education and teaching safe firearms handling. Gunsmiths rely on them, too.



- 22 LR Training Rounds 12 p/pack ..... (#12206)
- 22 LR Training Rounds 6 p/pack ..... (#12208)
- 17 HMR Training Rounds 6 p/pack ..... (#12202)
- 17 Win Super Mag Training Rounds 6p/pack ..... (#12282)
- 22 Win Mag Training Rounds 6 p/pack ..... (#12204)

**For pricing visit our website  
www.lymanproducts.com**



Precision Training Rounds for Dry Firing

We've listened to your requests, and paid attention to the folks who buy our A-Zoom Snap Caps the most, and now we've tried to make things as easy as possible for some of our most common customers by putting together the calibers you need into handy variety packs.

**A-Zoom® Variety Packs**

Our trusted A-Zoom Snap Caps, perfect for training, now conveniently packaged to meet your specific needs. Get all of the calibers you need at a substantial savings over buying multiple calibers individually.



**NRA Instructor Pack:**

Designed to give NRA instructors all the most popular handgun training calibers in one convenient pack. Includes: (3) .22LR, (2) .380, (2) 9mm, (2) .40, (2) .45 A-Zoom Variety Pack NRA instructor ..... (#16190)



**Ideal for Tactical Training**

**Military/LE Pack:**

An all-inclusive combination of all the most common calibers used by today's military and law enforcement groups. Includes: (2) 9mm, (2) .40, (2) .45, (2) .223, (2) .308, (2) 12ga. A-Zoom Variety Pack Military/LE ..... (#16185)



**Top Rifle Pack:**

This pack includes all the most commonly used rifle training calibers, including rimfire. Includes: (2) .223, (1) .308, (3) .22 (plastic), (1) .30-06, (1) 7.62 x 39mm A-Zoom Variety Pack Top Rifle ..... (#16195)



**StrikerCaps**

Our extremely popular A-Zoom Snap Caps are the best choice for safety training, function testing and dry firing practice. Their rugged design has proven to withstand thousands of dry fires while still protecting the firing pin. One drawback with dry firing snap caps however is when they are used in striker fire type pistols. These firearms require that the slide be drawn back to cock the pistol, which then extracts and ejects the snap cap from the pistol. Our new StrikerCaps solve this problem. StrikerCaps are made without a rim and are equipped with a centering o-ring which grips the chamber walls and keeps the snap cap in place in the chamber. Once it is chambered, simply rack the slide to cock the pistol. StrikerCaps will absorb the firing pin hit just like standard A-Zooms, however will stay in place for quicker, easier dry fire practice. StrikerCaps will be available for 380 Auto, 9mm, 40 S&W and 45 ACP.

- StrikerCap 380 Auto 2/pk ..... (#17101)
- StrikerCap 9mm 2/pk ..... (#17102)
- StrikerCap 40 S&W 2/pk ..... (#17103)
- StrikerCap 45ACP 2/pk ..... (#17104)



**For pricing visit our website  
www.lymanproducts.com**

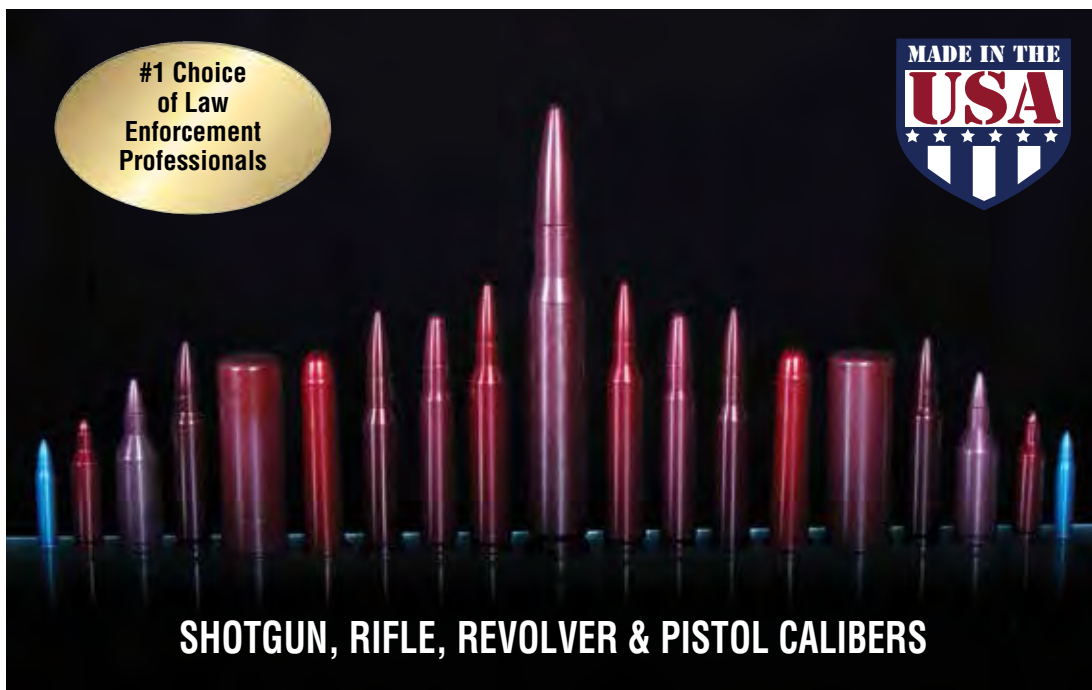

For safety training, function testing or safely decocking without damaging the firing pin, A-Zoom training rounds are much more than conventional snap-caps. They are precision CNC machined from solid aluminum to precise cartridge dimensions, then hard anodized for ultra-smooth functioning and long life.

In addition, each round has A-Zoom's remarkably durable "Dead Cap" proven to withstand over three thousand dry fires while protecting the firing pin. A-Zoom Snap Caps last over 30 times longer than conventional plastic examples and are available in over 120 sizes from .22 Hornet to the .50BMG.

**SHOTGUN - 2/pk**

12210 10 GAUGE

**SHOTGUN - 2/pk**

12211 12 GAUGE

12212 16 GAUGE  
12213 20 GAUGE

12214 28 GAUGE  
12215 410 BORE

**PISTOL**

**GROUP A - 5/pk**

15153 32 Auto  
15113 380 Auto  
15116 9mm Luger  
15159 357 Sig  
15114 40 S & W  
15117 10mm Auto  
15115 45 Auto

**GROUP B - 5/pk**

15152 25 Auto  
15133 7.62 Tokarev  
15132 9mm Makarov  
15158 38 Super  
15130 5.7 x 28mm  
15118 45 Glock

**REVOLVER**

**GROUP A - 6/pk**

16118 38 Special  
16119 357 Magnum  
16123 44-40 Win  
16121 44 Special  
16120 44 Magnum  
16124 45 Colt

**GROUP B - 6/pk**

16135 32 S&W Long  
16137 32 H&R Mag  
16128 38-40 Win  
16127 41 Magnum  
16126 454 Casull  
16129 460 S&W  
16146 480 Ruger  
16144 500 S&W

**GROUP C - 6/pk**

16160 32 S&W Short  
16112 32-20 Win  
16125 38 S&W  
16141 44 Colt

**GROUP A - 2/pk**

12218 204 Ruger  
12236 22 Hornet  
12238 222 Rem  
12222 223 Rem  
12306 22 Nosler  
12254 22-250 Rem  
12223 243 Win  
12305 6mm Creedmoor  
12256 25-06 Rem  
12304 6.5 Grendel  
12251 6.5 x 55 Swed  
12224 270 Win  
12219 270 WSM  
12252 7mm Rem Mag  
12225 30 Carbine  
12229 30-30 Win  
12228 308 Win  
12227 30-06 Sprg  
12237 300 Win Mag  
12296 300 WSM  
12234 7.62 x 39  
12226 303 British  
12235 8 x 57 Mauser  
12207 325 WSM  
12230 338 Win Mag  
12231 45-70 Govt  
12303 450 Bushmaster  
12301 458 SOCOM  
12302 50 Beowulf

**GROUP B - 2/pk**

12247 7mm-08 Rem  
12232 7 x 57 Mauser  
12242 7 x 57 R  
12293 7 x 64 Brenneke  
12244 7 x 65 R  
12281 7.5 x 55 Swiss  
12233 7.62 x 54 Russ  
12240 9.3 x 62 Mauser  
12269 9.3 x 74 R  
12248 375 HH Mag  
12267 458 Win Mag  
12285 5.45 x 39R  
12271 300 AAC Blackout  
12300 6.5 Creedmoor



12401 224 Valkyrie 2/pk

**RIFLE CALIBERS**

**GROUP C - 2/pk**

12217 17 Remington  
12299 223 WSSM  
12295 5.6 x 50R Mag  
12241 5.6 x 52 R  
12298 243 WSSM  
12276 6mm Rem  
12258 257 Roberts  
12287 260 Rem  
12294 6.5 x 57 R  
12291 6.5 Carcano  
12275 6.8 MM Rem  
12246 280 Rem  
12239 30 R Blaser  
12284 300 Wea Mag  
12272 300 Savage  
12263 300 Rem Ultra Mag  
12264 7.7 x 58 JAP  
12250 338 Lapua Mag  
12261 38-55 Win  
12288 416 Rem Mag  
12270 444 Marlin  
12209 458 Lott  
12216 50-70 Govt  
12265 8 x 57 R

**GROUP D - 1/pk**

LARGE RIFLE/NITRO EXPRESS

11401 416 Rigby  
11405 470 NE  
11451 50 BMG

**GROUP E - Custom**

15111 8mm Auto Nambu  
12259 32 Win Spl



**For pricing visit our website  
www.lymanproducts.com**



## Launch Pad Electric Trap



The Trius Launch Pad is perfect for clay target practice, whether alone or with a group of friends. This powerful machine is easy to transport and set-up, yet throws like commercial quality traps. The electric trap features a foot pedal release with a long 15' cable, a fast reset time for continuous action, a 50 target magazine, and a 60+ yard throwing distance. The target magazine is quick to install and remove, making it easy to transport the trap. The rear legs feature quick release pull pins making it easy to select from the 3-position angle settings. The legs are also drilled to accept the supplied grounding stakes, which allow the trap to be secured in position. For user safety, the trap is equipped with an arm path indication ring, a 6' battery connection cable and a disarming switch.

- 60+ yard throwing distance
- 50 target magazine
- Easy to transport and set-up
- Foot pedal release switch
- 3-position angle adjustment
- Includes grounding stakes
- Works on 12 Volt deep cycle battery (not included)

Launch Pad Electric Single Clay Launcher (#10210)



Easy to use controls



Tough steel body and legs



Rear legs can be quickly adjusted for elevation



Convenient foot pedal release switch



Throwing arm is gear-driven for smooth, reliable operation





**92S The Original TRIUS® Trap  
Built for the Serious Shooter!**



For more than 60 years the Original Trius Trap has been the trap that others have been judged by. The trap can be adjusted to throw beyond regulation distance. In addition, it throws doubles including piggyback doubles. Held in place with foot or mounted to a tire (bolt furnished), the trap features a High Angle Target Retainer for those challenging high angle targets. Large adjustment knobs make the TRIUS trap fully adjustable without tools.

92S Trius Trap ..... (#10205)

**TRIOUS® Birdshooter 2™**

**TRIOUS Quality Priced for the Recreational Shooter!**



The TRIUS Birdshooter has many of the fine features of our original foot trap but priced for the occasional shooter. Don't let the low price fool you, this trap has TRIUS quality and performance. A bit lighter weight than the original TRIUS Trap, this trap will out perform other traps in its price range. Regulation singles and piggyback doubles make this an excellent choice for the beginner and/or experienced shooter. Can be held with foot or tire mount (bolt furnished). Aluminum arm plus oil impregnated bushings give years of trouble-free shooting. A High Angle Target Retainer is included for adding variety to your shooting. Fully adjustable without tools.

Birdshooter 2 ..... (#10220)





**The TRIUS® 1-Step™**

**A Trius Original**



**One easy step cocks & releases target, almost effortlessly.**

One person can throw and shoot! The most popular member of the TRIUS line, the One Step has become our best seller, whether you enjoy shooting alone or with a group. The TRIUS One Step is almost effortless to use. Arm is set and targets are placed on arm without tension. Step on pedal to put tension on the arm and release targets in one motion. Aluminum arm plus oil impregnated bushings deliver years of trouble-free shooting. Throw regulation singles plus piggyback doubles. High Angle Target Clip Included. Large knobs for adjusting tension and vertical angle make the TRIUS One Step trap fully adjustable without tools.

Trius 1-Step (21 lbs.) ..... (#10201)



**EyePal®**  
**Perfect Vision for Hunting or Target Shooting**

**PATENTED**

This amazing product instantly improves eye focus for any shooter.

- Eliminates target fuzzing and distortion.
- Applies directly to your eyeglass lens.
- Won't scratch or harm your glasses, removes easily when not in use.
- Works with any prescription or safety glasses.
- Available in models for Bow Hunting, Handgun and Rifle Shooting
- CMP Approved for National Trophy Pistol and Rifle Match Competition

Are you are frustrated because you can no longer make out your sights AND the target when aiming a rifle, handgun, or bow? Simply apply the EyePal to your glasses, and you'll be back on the range and shooting better than you have in years! The EyePal provides a small image where everything is in focus. This is particularly useful to shooters who have limited near vision but have good far vision.

The EyePal is a modern adaptation of the century-old peep sight. The EyePal enables you to simultaneously see the target, your front and rear sights — all in focus. And since its made out of a static cling material, it can be easily placed on and off of reading, prescription and safety glasses — without marring the surface or leaving any residue. Compact, lightweight and virtually indestructible, the EyePal is the ultimate addition to any shooter's kit.

- EyePal Rifle ..... (#3112000)
- EyePal Bow/Handgun ..... (#3112001)
- EyePal Combo Pack (1 Rifle, 1 Handgun) ..... (#3112002)

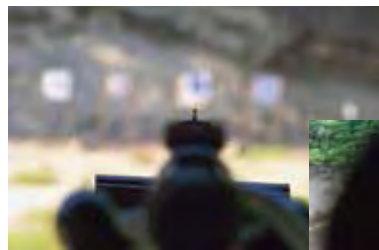

Fuzzy target without EyePal®

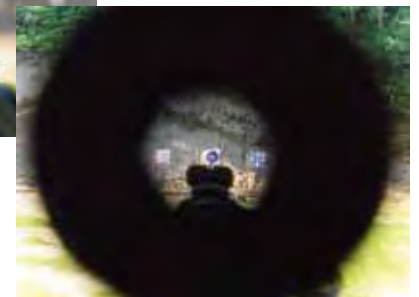

Sight picture in focus with EyePal®!

Lyman Products Corporation  
475 Smith Street  
Middletown, CT 06457

PRSRT STD  
US POSTAGE PD  
LYMAN PRODUCTS  
CORPORATION

**Check out  
What's New on our website,  
find us on facebook,  
and watch us on youtube.**

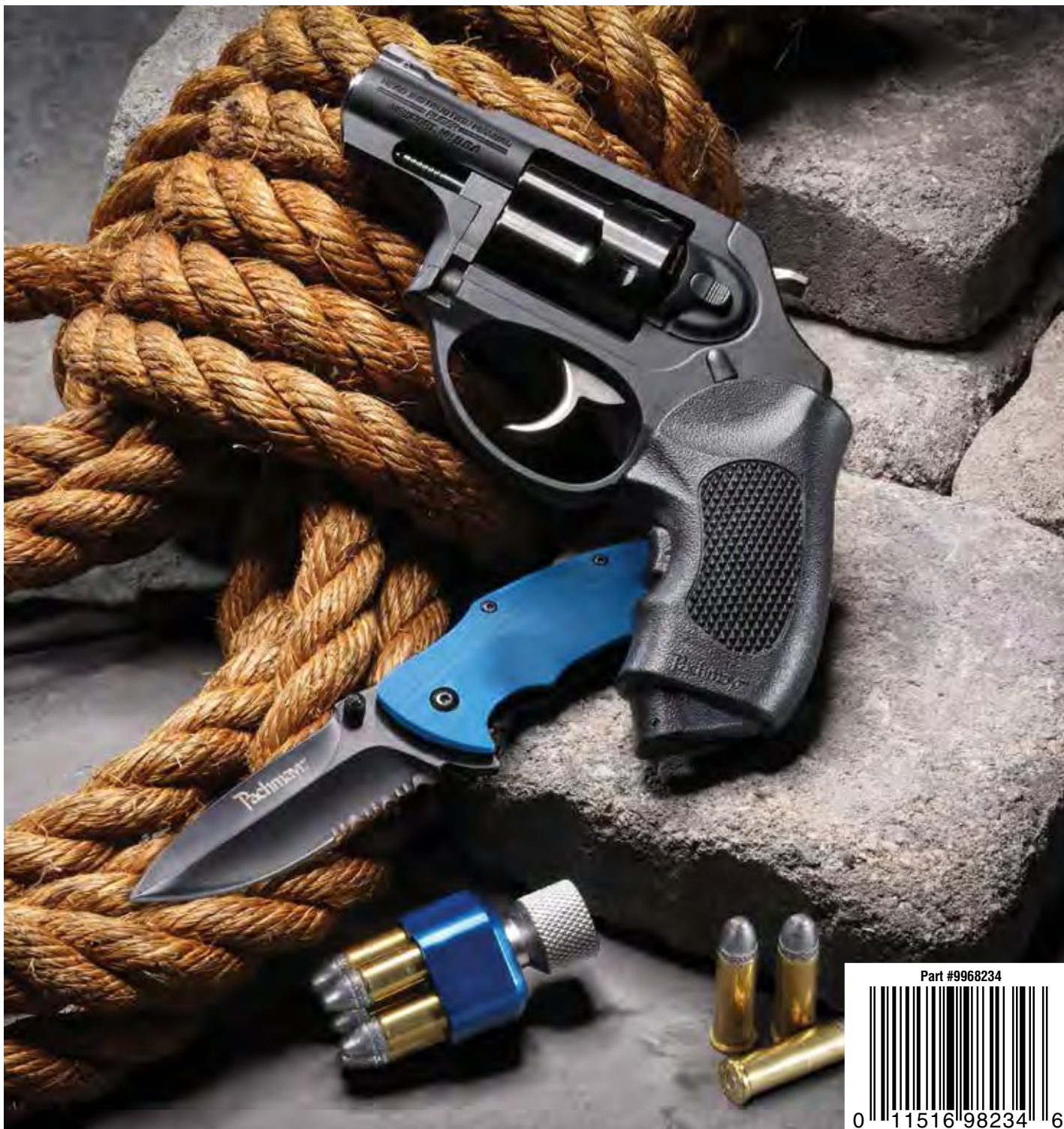

Part #9968234

0 11516 98234 6

Printed in the U.S.A.